

Summary for CLM-232XX-XX Series

In the 21 century , the technology development is growing faster and faster . The protections of electric devices are more and more important recently . CLM is involved in designing both good-looking and suitable cabinet / rack / wallmount for every kind of necessities of customers . And development of kinds of accessroies is growing faster and faster.



CLM-232xx-xxAA

19" 232XX SERIES WALLMOUNT



Applications

- Wallmount distribution
- Corridor distribution
- Office distribution
- Network distribution

Installation Type

Wallmount

Design Features

- Stable construction of the main frame by CLM's specific design
- Symmetrical frame
- Removable side panels & front door
- Removable roof panel & bottom panel
- Swingable side panels
- Swingable front door
- Cable management
- Passive ventilator

Benefits

- Integral passive ventilator
- 482.6mm(19") interior for mounting angles
- Interior additional hoels for installing accessories
- Depth variants
- Modular enclosure diversity with an extensive range of system accessories
- Easy assembled & dismantled.
- Particularly cost-effective complete system
- Saving warehouse space due to D.I.Y flat-package
- Attractive outlooking

Page I33~I60



CLM-232xx-xxAB

- Office distribution
- Mini-server racks
- Small business department
- Home workstation



CLM-232xx-xxAC

- Office distribution
- Mini-server racks
- Small business sector
- Home workstation



CLM-232xx-xxCA

- Wallmount distribution
- Corridor distribution
- Office distribution



CLM-232xx-xxCB

- Wallmount distribution
- Corridor distribution
- Office distribution

Floor type

Wallmount

Wallmount

Wallmount

- Stable construction of the main frame by CLM's specific design
- Symmetrical frame
- Removable side panels & Front door
- Removable roof panel & Bottom panel
- Swingable side panels
- Swingable front door
- Cable management
- Passive ventilator

- Stable construction of the main frame by CLM's specific design
- Symmetrical frame
- Removable side panels & Front door
- Removable roof panel & Bottom panel
- Swingable side panels
- Swingable front door
- Cable management
- Passive ventilator

- Symmetrical Frame
- Graceful Front Door
- Removable Side Panels & Front Door
- Unremovable Roof Panel & Bottom Panel
- Pull-out Side Panels
- Passive Ventilation Concept

- Symmetrical frame
- Vented front door
- Removable side panels & Front door
- Unremovable roof panel & Bottom panel
- Pull-out side panels
- Passive ventilation Concept

- Integral passive ventilator
- Optional fans on the additional fan-holes of the roof panel & rear door
- Suitable for office use
- 482.6mm(19") interior for mounting angles
- Interior additional hoels for installing accessories
- Depth variants
- Modular enclosure diversity with an extensive range of system accessories
- Easy assembled & dismantled.
- D.I.Y flat-package
- Attractive outlooking

- Integral passive ventilator
- Fixable on the wall panel
- 482.6mm(19") interior for mounting angles
- Interior additional hoels for installing accessories
- Depth variants
- Modular enclosure diversity with an extensive range of system accessories
- Easy assembled & dismantled.
- Cost-effective complete
- Saving warehouse space due to D.I.Y flat-package
- Attractive outlooking

- Integral passive ventilator
- Fixable on the wall panel
- 482.6mm(19") interior for mounting angles
- Interior additional hoels for installing accessories
- Depth variants
- Modular accessories
- Easy assembled & dismantled.
- Cost-effective complete
- Designed unity of roof panel , bottom panel & wall panel
- Not flat-package but complete package

- Integral passive ventilator
- Fixable on the wall panel
- 482.6mm(19") interior for mounting angles
- Interior additional hoels for installing accessories
- Depth variants
- Modular accessories
- Easy assembled & dismantled.
- Cost-effective complete
- Designed unity of roof panel , bottom panel & wall panel
- Not flat-package but complete package

Page I33~I60

Page I33~I60

Page I61~I70

Page I61~I70

Summary for CLM-232XX-XX A Series

Features :

- Applications for networking & communication system & monitoring system .
- Elegant design can be a wall decoration .
- The additional holes on the frame can be used for the cable management.
- Vented slots on the top panel , the bottom panel & the front door can efficiently reduce the interior heat for higher ventilation.
- Spring-load hinges for setting and removing the front door in one second.
- The sponges assembled on the cable entries can block dusty & keep cable from hurt.
- Design of roof panel & bottom panel for easily assembled & dismantled.
- Tempered glass fastened on a robust steel frame to become a secure front door out of block.
- Adequate loading of wallmount fasten on the wall .
- Powder coating for RoHS compliant .
- Black & Beige for color selections .



"One-second" design :
Dismantle the front door & side panels just by one click in one second.

Ground Type AB

P.P. I43~I50

Wallmount Type AA

P.P. I35~I42

Wallmount Type AC

P.P. I51~I57

"D.I.Y." exporting flat-package for saving long distance transportation and warehouse cost

19" 232XX SERIES WALLMOUNT

232xx-xxAA

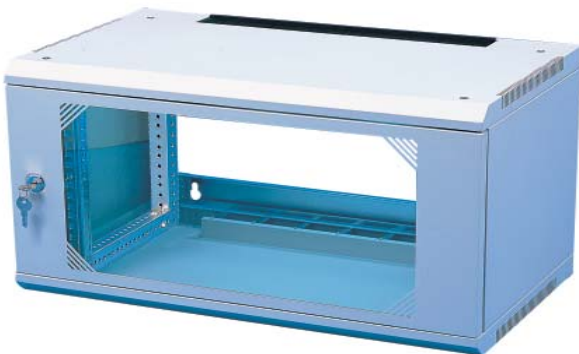

Dimensions

Width	600 mm
Depth	250 mm , 300mm , 350mm , 400mm 450mm , 500mm , 550mm , 600mm , 650mm
Height	4U~24U

232xx-xxAB



Dimensions

Width	600 mm
Depth	600mm , 650mm , 700mm , 750mm 800mm , 850mm
Height	12U~24U



2
Cable entry :
 The sponge entry on panel can protect the outlooking of cable from scraped and dust outside.



Cool environment :
 Optional two fans on the roof panel can drop the interior temperature.



3
Set for kinds of rail :
 Many rails can be set on the F-shaped mounting angles .



The cable management :
 Let the cable management become quicker , safer & neater .



4
Passive Ventilator :
 The slots on the roof, bottom panels & front door for efficient heat-dissipation .

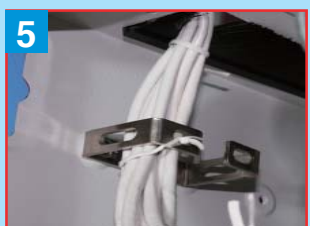

5
Wall Panel :
 Holes on the wall panel are used for something need to fixing on the wall panel ,like cable rings.

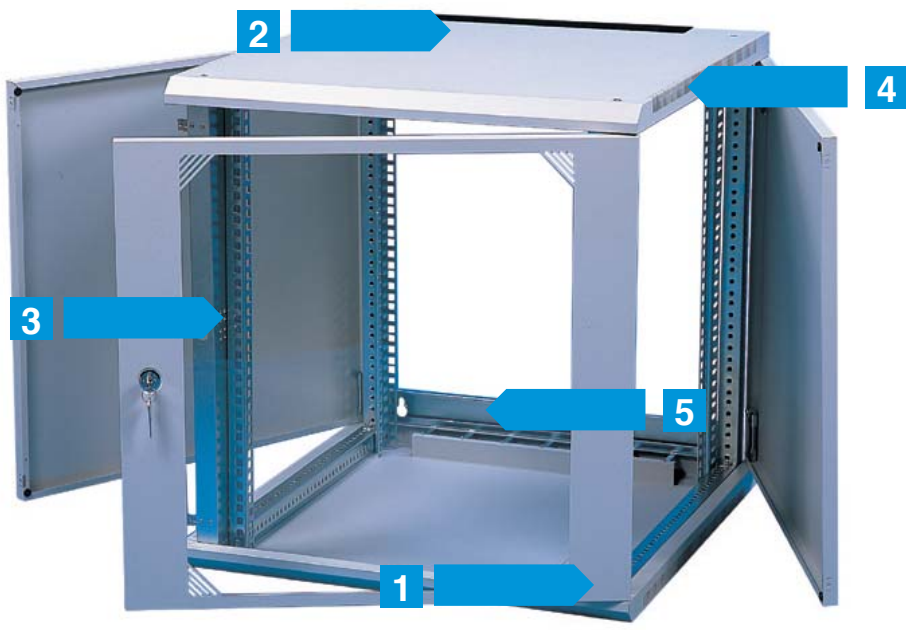

19" 232XX SERIES WALLMOUNT

232xx-xxAC



Dimensions

Width	600 mm
Depth	300mm , 350mm , 400mm , 450mm 500mm , 550mm , 600mm , 650mm
Height	6U~24U

232xx-xxAC Operations



Construction Overview CLM-232XX-XX A Series

19" 232XX SERIES WALLMOUNT

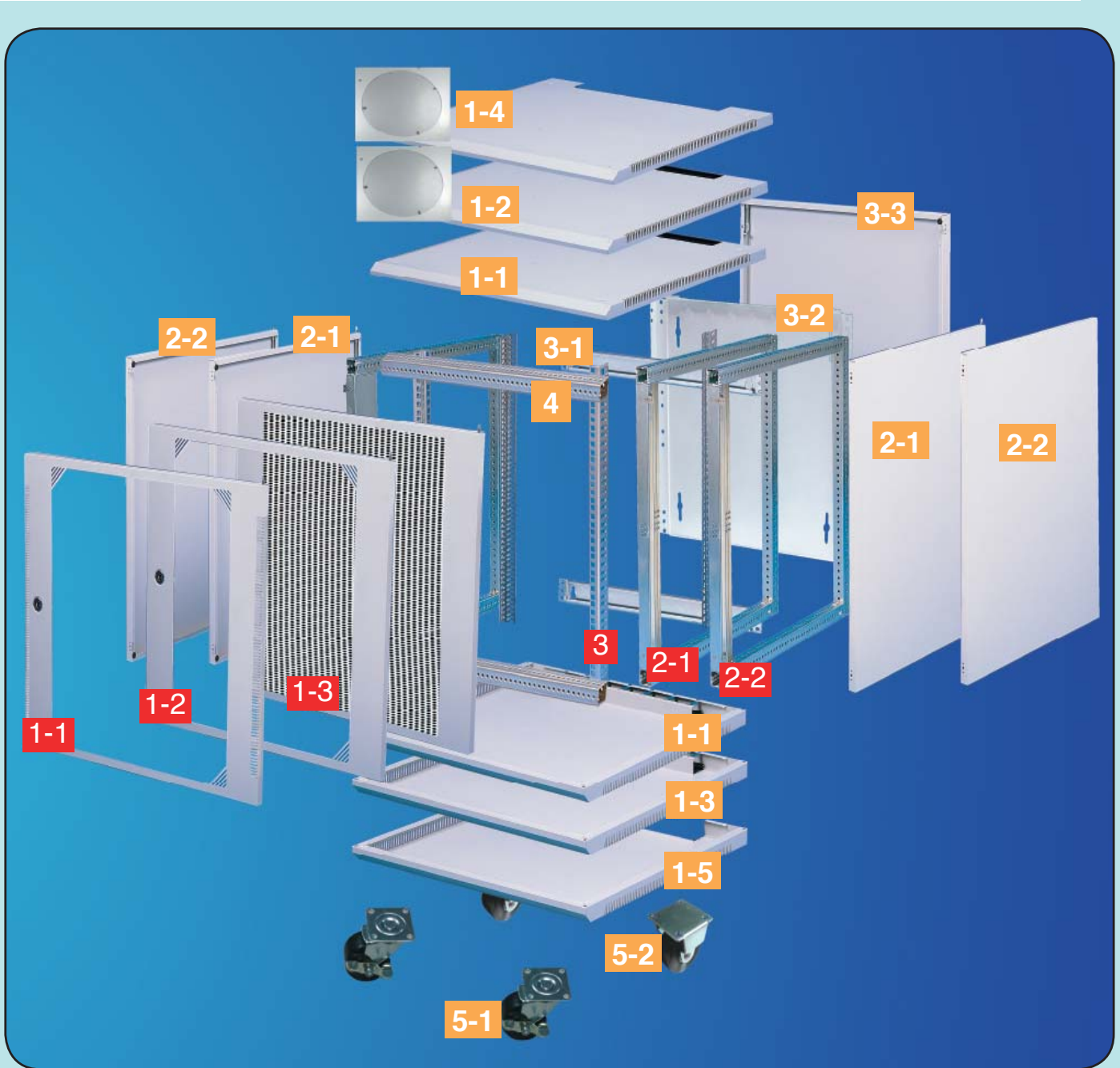

Brush Strips



M-shaped Fixer



Fan Variants



CLM-232xx-xx A Series Overview

19" Wallmount Rack for Distributors & Under Desk Mini Server

19" 232XX SERIES WALLMOUNT

General Accessories(Optional)

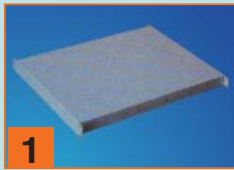

1



10



19



2



11



20

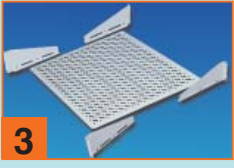

3



12



21

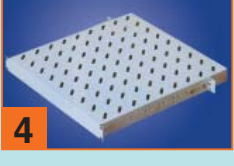

4



13



22



5



14



23



6



15



24



7



16



25



8



17



26

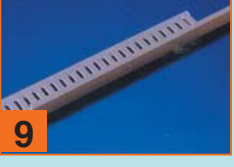

9



18

Standard Equipment: (Included)

1.		
1-1	CLM-882403-6xx	Vented Tempered Glass Door..... I58
1-2	CLM-882225-6xx	Tempered Glass Door..... I58
1-3	CLM-882356-6xx	Vented Mesh Door..... I59
2.		
2-1	CLM-882227-xxxx	Main Frames.....I41,I49,I56
2-2	CLM-882404-xxxx	Main Frames(AB)..... I48
3.	CLM-612615-00	F-shaped mounting Angle..... I59

Standard Equipment: (Included)

1.		
1-1	CLM-882228-6xx	Bevel Flat Panel(AA).....I41
1-2	CLM-882365-6xx	Vented Bevel Roof Panel(AB).....I47
1-3	CLM-882366-6xx	Bevel Bottom Panel(AB)..... I47
1-4	CLM-882401-6xx	Vented Bevel Roof Panel(AC).....I55
1-5	CLM-882402-6xx	Bevel Bottom Panel(AC)..... I55
2.		
2-1	CLM-882226-xxxx	Swing Side Panel(AA)(AB)..... I42,I48
2-2	CLM-882411-xxxx	Pull-out Side Panel(AC)..... I57
3.		
3-1	CLM-612613-02	Wall Hinge(AA).....I42
3-2	CLM-612773-xx	Rear door(AC)..... I50
3-3	CLM-882405-xx	Wall panel.(AB)..... I56
4.	CLM-612537-xx	Strengthenign bar(AB)..... I49
5.		
5-1	CLM-662134-00	Light-Duty Rigid (Rear)(AB)..... I50
5-2	CLM-662131-00	Light-Duty(Front)(AB).....I50

Standard Equipment: (Optional)

1.	CLM-882033	Overlapped Component shelf.....	K1
2.	CLM-882026	Adjustable Component shelf.....	K1
3.	CLM-882060	Vented & adjustable Component shelf	K1
4.	CLM-882104	Vented Fixed Component shelf.....	K2
5.	CLM-882025	Telescopic slide rails Slide-in Component shelf.....	K2
6.	CLM-882030	Drawer 1U,2U,3U.....	K2-K3
7.	CLM-612027	Sheet steel blanking panels.....	K18
	CLM-612001	Aluminum blanking panels.....	K18
8.	CLM-312002-17/30	Earth straps.....	K29
9.	CLM-512007	Cable wiring duct.....	K21
10.	CLM-612199	Cable shunting rings,steel.....	K19
11.	CLM-882054	3 Sections server rail with Brackets	K9-K17
	CLM-882053	3 Sections server rail with Brackets	K9-K17
	CLM-882052	2 Sections server rail with Brackets.....	K9-K17
	CLM-882051	2 Sections server rail with Brackets.....	K9-K17
12.	CLM-612030	Cable clamp rails.....	K20
13.	CLM-882089-00	cable shunting strips,.....	
14.	SSL-1024 HUB	24 port Nway switch for Rack mounting..	K5
	SSL-1104/SSL-1108/SSL-1116KVN.....		K5
15.	CLM-882061	Power Socket strip & mounting bracket.....	K30
16.	CLM-612274	Patch panels.....	K22-K17
17.	CLM-882066	Cable gland panel.....	K19-K20
18.	CLM-911/2	Keyboard drawer with keyboard with mouse with Telescopic slide rails.....	K4
19.	CLM-662097	Swelling Boon-Bolt hinger.....	K37
20.	CLM-882129	Component shelf.....	I9
21.	CLM-882142	Cabling management strip.....	K20
22.	CLM-882199	Cable shunting rings strip.....	K19
23.	CLM-662009	Shelf-tapping washers screw.....	K33-K40
24.	CLM-882003	Cage Nuts.....	K33-K40
25.	CLM-882170	1U Rack-mounted 3 fans	E65
	CLM-882171	1U Rack-mounted 6 fans with 1 Pair of Slide Rails.....	E65
	CLM-882046	Active fan 3U.....	E66
26.	CLM-882124-00	Earthing Kit.....	E68

CLM-23225-xxAA □
W600 X D250 X H(4U to 24U)

CLM-23230-xxAA □
W600 X D300 X H(4U to 24U)

CLM-23235-xxAA □
W600 X D350 X H(4U to 24U)

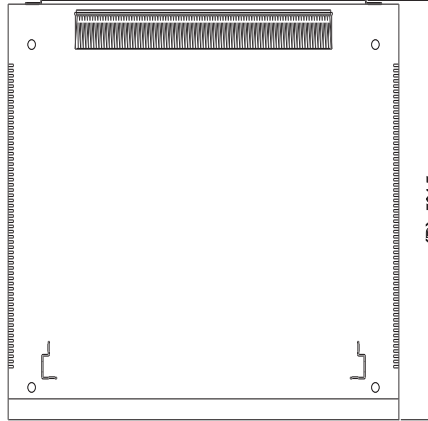

Component Parts	Num	Model No.
Roof & Bottom Panel	1	882228
Frame	2	882227
Vented Glass Door	1	882403
Side Panel	2	882226
Wall Hinger	2	612613
F-shaped mounting angle	2	612615
Washers of F-shaped	4	612590
Fixer for F-shaped & frame	2	612752
Self-tapping Screw 12#24	28	662127
Self-tapping Screw M4	4	662035-06
Self-tapping Washer Screw	12	612009-12
Cage Nut M6	12	882003-06

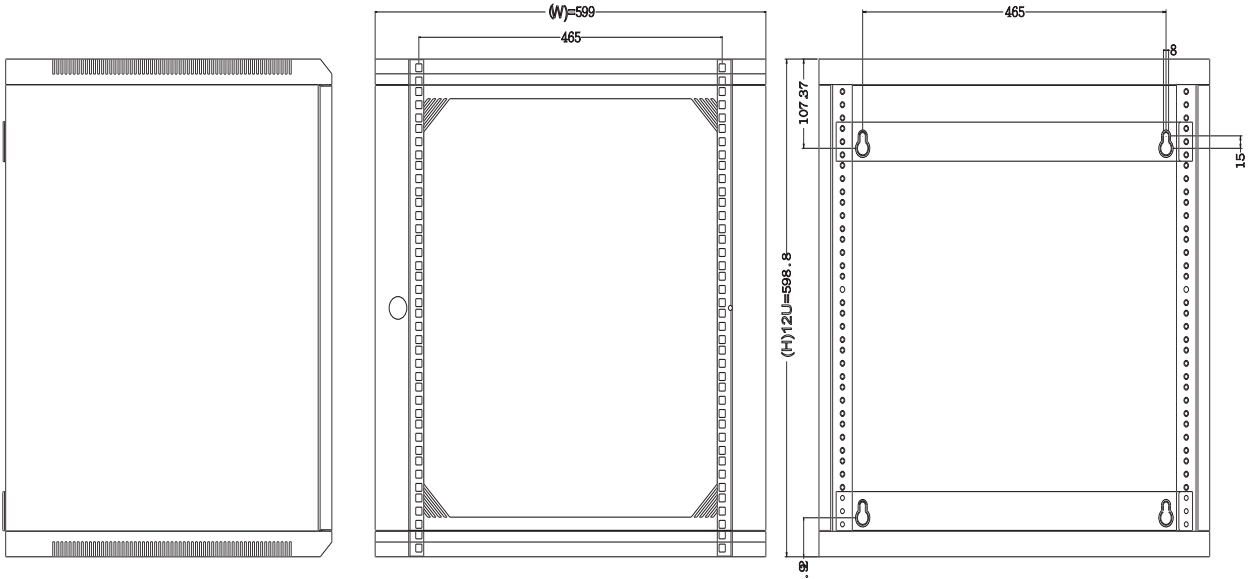

Dimension Table:

Total Unit(U)	4	5	6	7	8	9	10	11	12	13
Total Height (mm)	241.80	286.25	330.70	375.15	419.60	464.05	508.50	552.95	597.40	641.85
Width	600	600	600	600	600	600	600	600	600	600
Clearance Size (1U=44.45mm)	177.8	222.25	266.7	311.15	355.6	400.05	444.5	488.95	533.4	577.85
Model No.	CLM- 23225-04AA □	23225-05AA □	23225-06AA □	23225-07AA □	23225-08AA □	23225-09AA □	23225-10AA □	23225-11AA □	23225-12AA □	23225-13AA □
Depth =250	250	250	250	250	250	250	250	250	250	250
Shipping Dimension										
Complete	2.08	2.38	2.69	2.99	3.29	3.60	3.90	4.39	4.52	4.88
D.I.Y	1.55	1.55	1.65	1.91	2.24	2.24	2.25	2.25	2.29	2.59
G.W.										
Model No.	CLM- 23230-04AA □	23230-05AA □	23230-06AA □	23230-07AA □	23230-08AA □	23230-09AA □	23230-10AA □	23230-11AA □	23230-12AA □	23230-13AA □
Depth =300	300	300	300	300	300	300	300	300	300	300
Shipping Dimension										
Complete	2.42	2.77	3.13	3.49	3.84	4.20	4.55	5.13	5.28	5.71
D.I.Y	1.55	1.55	1.65	1.91	2.24	2.24	2.25	2.25	2.29	2.59
G.W.										
Model No.	CLM- 23235-04AA □	23235-05AA □	23235-06AA □	23235-07AA □	23235-08AA □	23235-09AA □	23235-10AA □	23235-11AA □	23235-12AA □	23235-13AA □
Depth =350	350	350	350	350	350	350	350	350	350	350
Shipping Dimension										
Complete	2.77	3.17	3.58	3.98	4.39	4.80	5.20	5.86	6.03	6.52
D.I.Y	1.6	1.68	1.88	2.09	2.29	2.54	2.79	3.04	2.59	2.78
G.W.										

Color choose : Fill number 5, 1 in the □

5 - RAL7035

1 - RAL9011

CLM-232xx-xxAA 19" WALL-MOUNT Rack

For Distributors & Under-Desk Mini Server Solutions

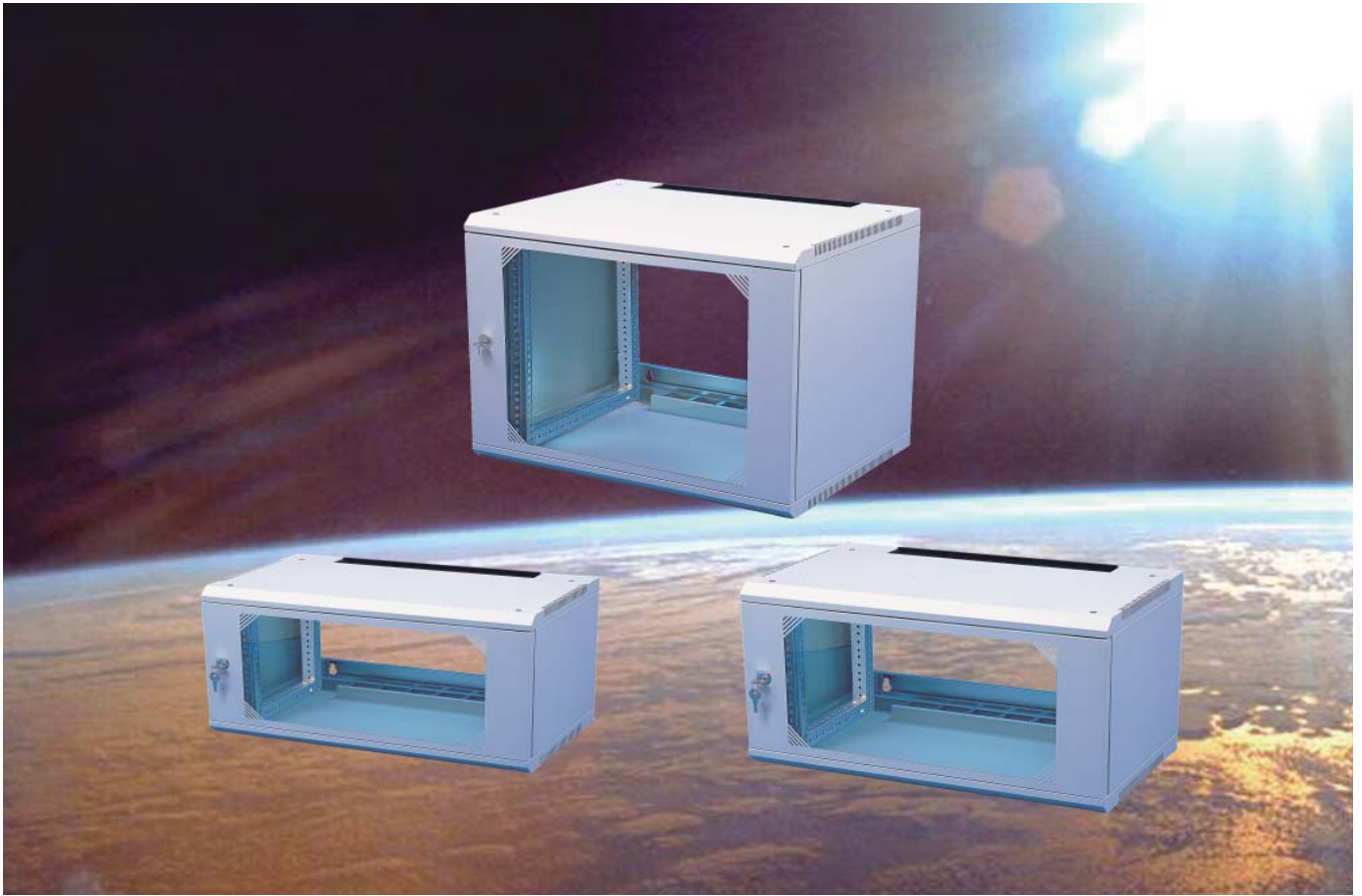

19" 232XX SERIES WALLMOUNT

Total Unit(U)	14	15	16	17	18	19	20	21	22	23	24
Total Height	686.3	730.75	775.2	819.65	864.1	908.55	953	997.45	1043.9	1086.35	1130.8
Width	600	600	600	600	600	600	600	600	600	600	600
Clearance Size (1U=44.45mm)	622.3	666.75	711.2	756.65	800.1	844.55	889	933.45	977.9	1022.35	1066.8
CLM-	23225-14AA	23225-15AA	23225-16AA	23225-17AA	23225-18AA	23225-19AA	23225-20AA	23225-21AA	23225-22AA	23225-23AA	23225-24AA
Depth =250	250	250	250	250	250	250	250	250	250	250	250
Dimension											
Complete	5.20	5.43	5.80	6.11	6.42	6.73	7.04	7.35	7.86	7.97	8.28
Complete	2.64	2.76	3.14	3.29	3.48	3.62	3.79	3.95	4.12	4.29	4.46
G.W.											
CLM-	23230-14AA	23230-15AA	23230-16AA	23230-17AA	23230-18AA	23230-19AA	23230-20AA	23230-21AA	23230-22AA	23230-23AA	23230-24AA
Depth =250	250	250	250	250	250	250	250	250	250	250	250
Shipping Dimension											
Complete	6.07	6.33	6.77	7.14	7.50	7.86	8.23	8.59	8.95	9.32	9.68
Complete	2.64	2.76	3.14	3.29	3.48	3.62	3.79	3.95	4.12	4.29	4.46
G.W.											
CLM-	23235-14AA	23235-15AA	23235-16AA	23235-17AA	23235-18AA	23235-19AA	23235-20AA	23235-21AA	23235-22AA	23235-23AA	23235-24AA
Depth =250	250	250	250	250	250	250	250	250	250	250	250
Shipping Dimension											
Complete	6.94	7.24	7.74	8.15	8.57	8.98	9.40	9.81	10.23	10.64	11.06
Complete	2.95	2.96	3.31	3.3	3.66	3.64	3.8	3.97	4.14	4.31	4.47
G.W.											

Color choose : Fill number 5, 1 in the

5 - RAL7035

1 - RAL9011

CLM-23240-xxAA
W600 X D400 X H(4U to 24U)

CLM-23245-xxAA
W600 X D450 X H(4U to 24U)

CLM-23250-xxAA
W600 X D500 X H(4U to 24U)

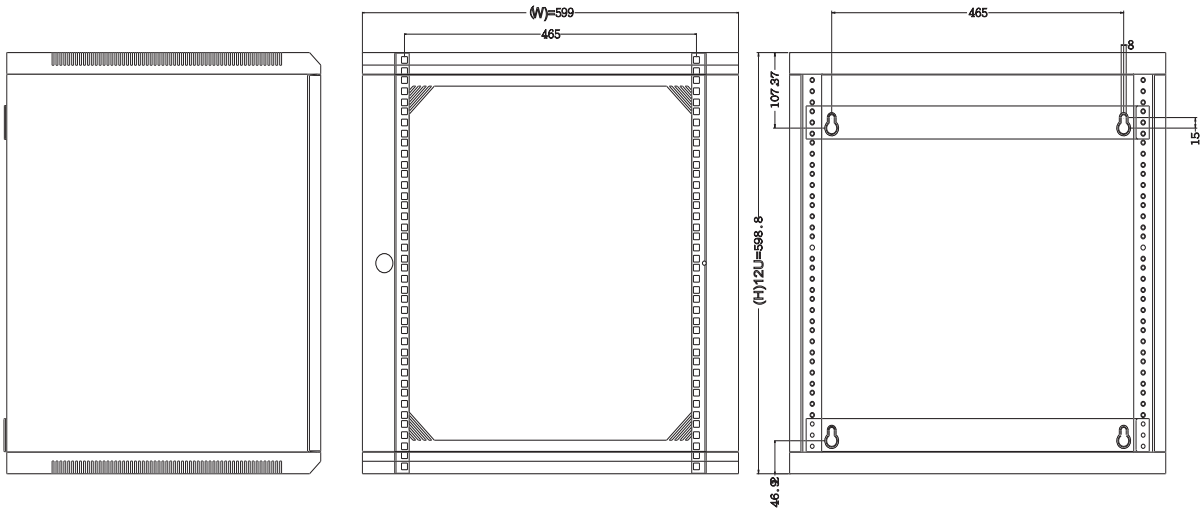
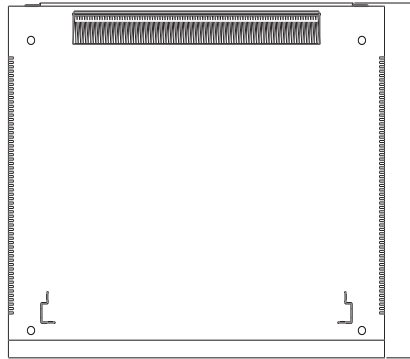

Component Parts	Num	Model No.
Roof & Bottom Panel	1	882228
Frame	2	882227
Vented Glass Door	1	882403
Side Panel	2	882226
Wall Hinger	2	612613
F-shaped mounting angle	2	612615
Washers of F-shaped	4	612590
Fixer for F-shaped & frame	2	612752
Self-tapping Screw 12#24	28	662127
Self-tapping Screw M4	4	662035-06
Self-tapping Washer Screw	12	612009-12
Cage Nut M6	12	882003-06

Dimension Table:

Total Unit(U)	4	5	6	7	8	9	10	11	12	13
Total Height (mm)	241.80	286.25	330.70	375.15	419.60	464.05	508.50	552.95	597.40	641.85
Width	600	600	600	600	600	600	600	600	600	600
Clearance Size (1U=44.45mm)	177.8	222.25	266.7	311.15	355.6	400.05	444.5	488.95	533.4	577.85
Model No.	CLM- 23240-04AA <input type="checkbox"/>	23240-05AA <input type="checkbox"/>	23240-06AA <input type="checkbox"/>	23240-07AA <input type="checkbox"/>	23240-08AA <input type="checkbox"/>	23240-09AA <input type="checkbox"/>	23240-10AA <input type="checkbox"/>	23240-11AA <input type="checkbox"/>	23240-12AA <input type="checkbox"/>	23240-13AA <input type="checkbox"/>
Depth =400	400	400	400	400	400	400	400	400	400	400
Shipping Dimension										
Complete	3.12	3.57	4.03	4.48	4.94	5.40	5.85	6.59	6.79	7.33
D.I.Y	1.71	1.98	2.11	2.52	2.52	2.71	2.79	3.04	3.26	3.78
G.W.										
Model No.	CLM- 23245-04AA <input type="checkbox"/>	23245-05AA <input type="checkbox"/>	23245-06AA <input type="checkbox"/>	23245-07AA <input type="checkbox"/>	23245-08AA <input type="checkbox"/>	23245-09AA <input type="checkbox"/>	23245-10AA <input type="checkbox"/>	23245-11AA <input type="checkbox"/>	23245-12AA <input type="checkbox"/>	23245-13AA <input type="checkbox"/>
Depth =450	450	450	450	450	450	450	450	450	450	450
Shipping Dimension										
Complete	3.46	3.96	4.48	4.98	5.48	6.00	6.50	7.32	7.54	8.15
D.I.Y	1.88	2.11	2.34	2.62	2.80	2.99	2.99	3.02	3.26	3.78
G.W.										
Model No.	CLM- 23250-04AA <input type="checkbox"/>	23250-05AA <input type="checkbox"/>	23250-06AA <input type="checkbox"/>	23250-07AA <input type="checkbox"/>	23250-08AA <input type="checkbox"/>	23250-09AA <input type="checkbox"/>	23250-10AA <input type="checkbox"/>	23250-11AA <input type="checkbox"/>	23250-12AA <input type="checkbox"/>	23250-13AA <input type="checkbox"/>
Depth =500	500	500	500	500	500	500	500	500	500	500
Shipping Dimension										
Complete	3.81	4.36	4.93	5.48	6.03	6.60	7.15	8.05	8.29	8.96
D.I.Y	2.12	2.34	2.57	2.88	3.07	3.07	3.26	3.27	3.26	3.78
G.W.										

Color choose : Fill number 5, 1 in the

5 - RAL7035

1 - RAL9011

CLM-232xx-xxAA 19" WALL-MOUNT Rack

For Distributors & Under-Desk Mini Server Solutions

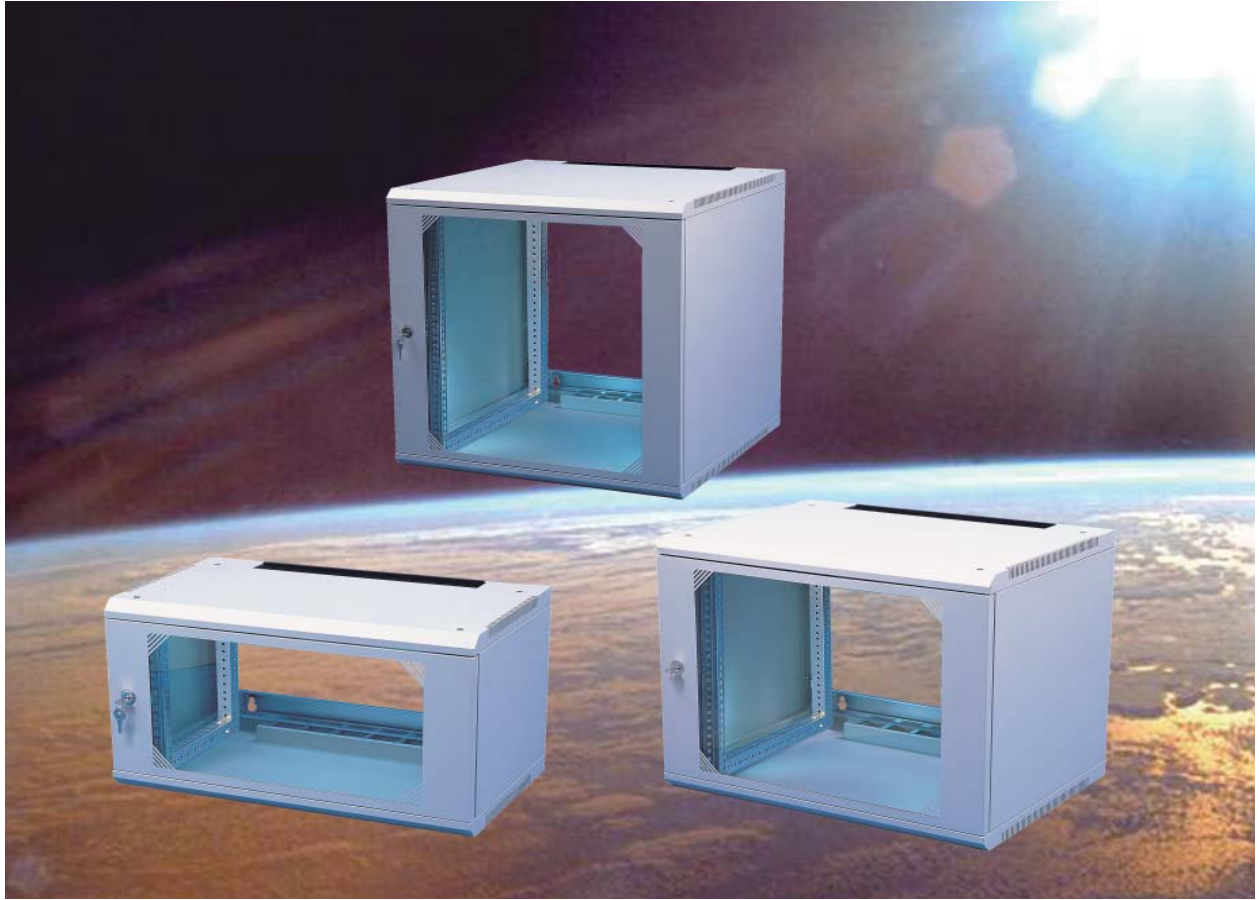

19" 232XX SERIES WALLMOUNT

Total Unit(U)	14	15	16	17	18	19	20	21	22	23	24
Total Height	686.3	730.75	775.2	819.65	864.1	908.55	953	997.45	1043.9	1086.35	1130.8
Width	600	600	600	600	600	600	600	600	600	600	600
Clearance Size (1U=44.45mm)	622.3	666.75	711.2	756.65	800.1	844.55	889	933.45	977.9	1022.35	1066.8
CLM-	23240-14AA	23240-15AA	23240-16AA	23240-17AA	23240-18AA	23240-19AA	23240-20AA	23240-21AA	23240-22AA	23240-23AA	23240-24AA
Depth =400	400	400	400	400	400	400	400	400	400	400	400
Shipping Dimension											
Complete	7.80	8.14	8.70	9.17	9.64	10.10	10.57	11.03	11.50	11.97	12.43
Complete	3.14	4.05	3.52	3.53	3.9	3.89	4.07	4.25	4.43	4.61	4.79
G.W.											
CLM-	23245-14AA	23245-15AA	23245-16AA	23245-17AA	23245-18AA	23245-19AA	23245-20AA	23245-21AA	23245-22AA	23245-23AA	23245-24AA
Depth =450	450	450	450	450	450	450	450	450	450	450	450
Shipping Dimension											
Complete	8.67	9.05	9.67	10.19	10.71	11.23	11.75	12.26	12.78	13.30	13.82
Complete	4.13	4.36	4.63	4.88	4.53	4.57	4.78	4.99	5.2	5.42	5.62
G.W.											
CLM-	23250-14AA	23250-15AA	23250-16AA	23250-17AA	23250-18AA	23250-19AA	23250-20AA	23250-21AA	23250-22AA	23250-23AA	23250-24AA
Depth =500	500	500	500	500	500	500	500	500	500	500	500
Shipping Dimension											
Complete	9.53	9.95	10.63	11.20	11.77	12.34	12.91	13.48	14.05	14.62	15.19
Complete	4.13	4.36	4.63	4.88	5.13	5.01	5.01	5.01	5.2	5.42	5.62
G.W.											

Color choose : Fill number 5, 1 in the

5 - RAL7035

1 - RAL9011

CLM-23255-xxAA □
W600 X D550 X H(4U to 24U)

CLM-23260-xxAA □
W600 X D600 X H(4U to 24U)

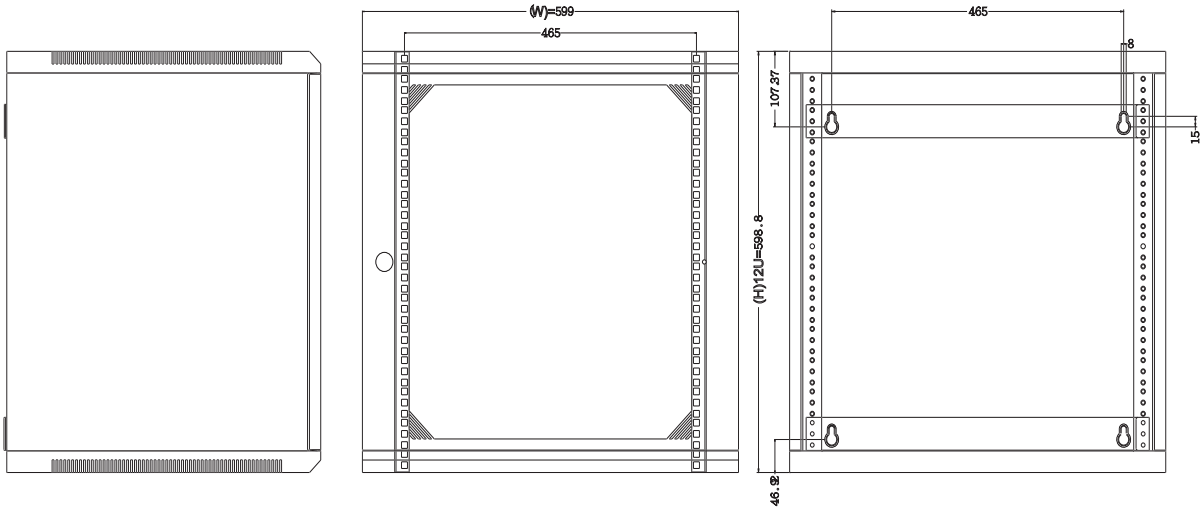
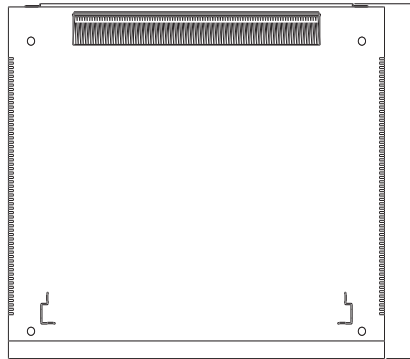

Component Parts	Num	Model No.
Roof & Bottom Panel	1	882228
Frame	2	882227
Vented Glass Door	1	882403
Side Panel	2	882226
Wall Hinger	2	612613
F-shaped mounting angle	2	612615
Washers of F-shaped	4	612590
Fixer for F-shaped & frame	2	612752
Self-tapping Screw 12#24	28	662127
Self-tapping Screw M4	4	662035-06
Self-tapping Washer Screw	12	612009-12
Cage Nut M6	12	882003-06

Dimension Table:

Total Unit(U)	4	5	6	7	8	9	10	11	12	13
Total Height (mm)	241.80	286.25	330.70	375.15	419.60	464.05	508.50	552.95	597.40	641.85
Width	600	600	600	600	600	600	600	600	600	600
Clearance Size (1U=44.45mm)	177.8	222.25	266.7	311.15	355.6	400.05	444.5	488.95	533.4	577.85
Model No.	CLM- 23255-04AA □	23255-05AA □	23255-06AA □	23255-07AA □	23255-08AA □	23255-09AA □	23255-10AA □	23255-11AA □	23255-12AA □	23255-13AA □
Depth =550	550	550	550	550	550	550	550	550	550	550
Shipping Dimension										
Complete	4.15	4.76	5.37	5.98	6.58	7.20	7.80	8.79	9.05	9.78
D.I.Y	2.01	2.28	2.45	3.14	3.35	3.35	3.36	3.46	3.54	3.78
G.W.										
Model No.	CLM- 23260-04AA □	23260-05AA □	23260-06AA □	23260-07AA □	23260-08AA □	23260-09AA □	23260-10AA □	23260-11AA □	23260-12AA □	23260-13AA □
Depth =600	600	600	600	600	600	600	600	600	600	600
Shipping Dimension										
Complete	4.50	5.15	5.82	6.47	7.13	7.78	8.45	9.52	9.80	10.59
D.I.Y	2.15	2.48	2.65	3.4	3.63	3.63	3.64	3.65	3.72	4.08
G.W.										

Color choose : Fill number 5, 1 in the □

5 - RAL7035

1 - RAL9011

CLM-232XX-XXAA 19" WALL-MOUNT Rack

For Distributors & Under-Desk Mini Server Solutions

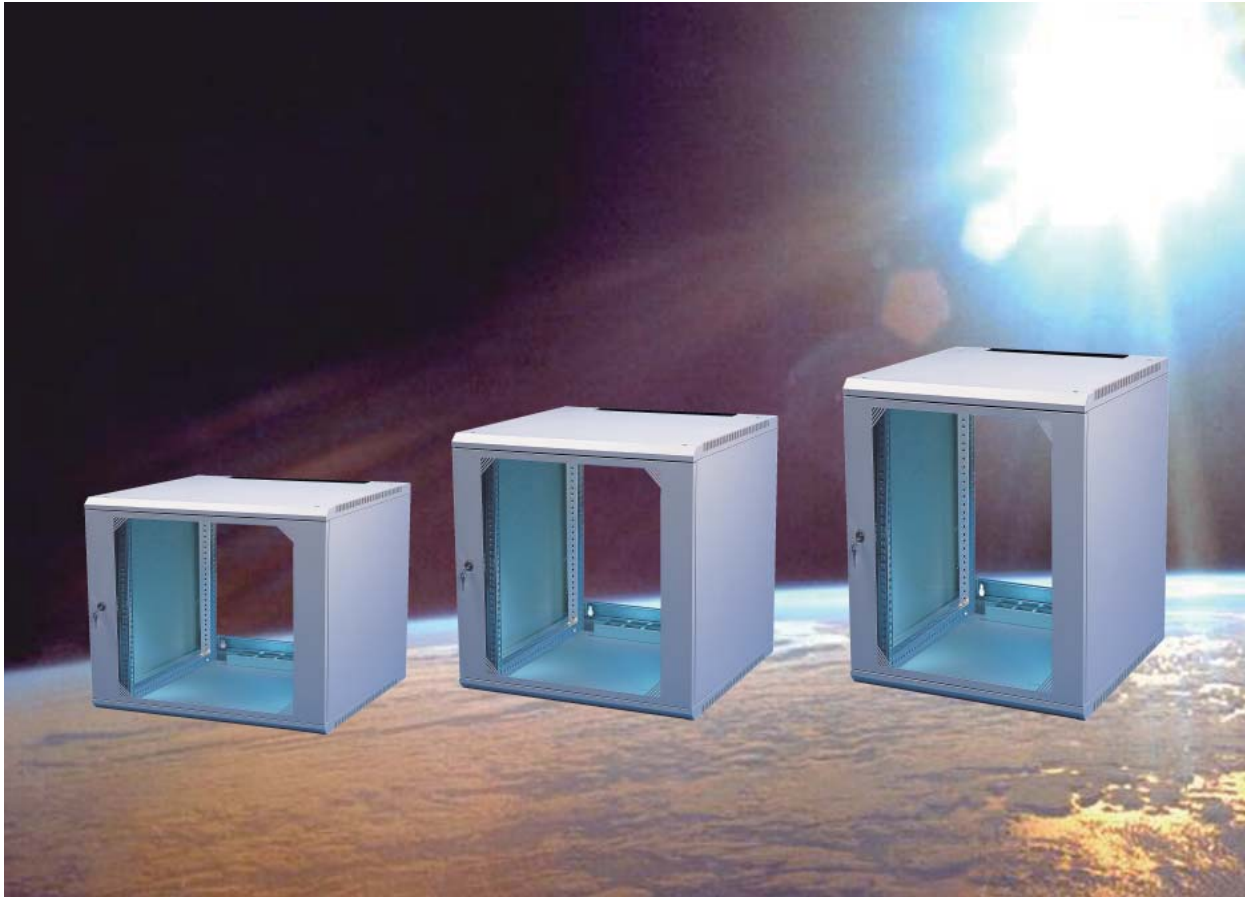

19" 232XX SERIES WALLMOUNT

Total Unit(U)	14	15	16	17	18	19	20	21	22	23	24
Total Height	686.3	730.75	775.2	819.65	864.1	908.55	953	997.45	1043.9	1086.35	1130.8
Width	600	600	600	600	600	600	600	600	600	600	600
Clearance Size (1U=44.45mm)	622.3	666.75	711.2	756.65	800.1	844.55	889	933.45	977.9	1022.35	1066.8
CLM-	23255-14AA	23255-15AA	23255-16AA	23255-17AA	23255-18AA	23255-19AA	23255-20AA	23255-21AA	23255-22AA	23255-23AA	23255-24AA
Depth =550	550	550	550	550	550	550	550	550	550	550	550
Dimension											
Complete	10.41	10.86	11.61	12.23	12.85	13.48	14.10	14.72	15.34	15.97	16.59
Complete	4.13	4.36	4.63	4.88	5.13	5.37	5.62	5.86	5.48	5.48	5.62
G.W.											
CLM-	23260-14AA	23260-15AA	23260-16AA	23260-17AA	23260-18AA	23260-19AA	23260-20AA	23260-21AA	23260-22AA	23260-23AA	23260-24AA
Depth =600	600	600	600	600	600	600	600	600	600	600	600
Shipping Dimension											
Complete	11.27	11.76	12.57	13.25	13.92	14.59	15.27	15.94	16.62	17.29	17.96
Complete	4.33	4.36	4.85	5.11	5.37	5.63	5.89	6.17	6.24	6.24	6.24
G.W.											

Color choose : Fill number 5, 1 in the

5 - RAL7035

1 - RAL9011

CLM-23260-xxAB□
W600 X D600 X H(12U to 24U)

CLM-23265-xxAB□
W600 X D650 X H(12U to 24U)

CLM-23270-xxAB□
W600 X D700 X H(12U to 24U)

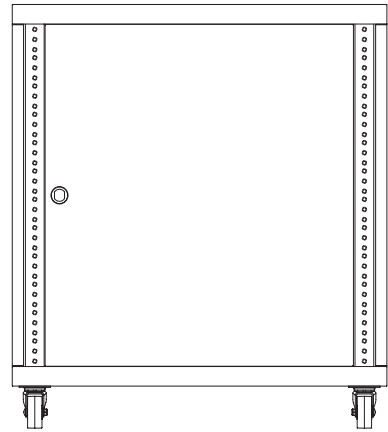
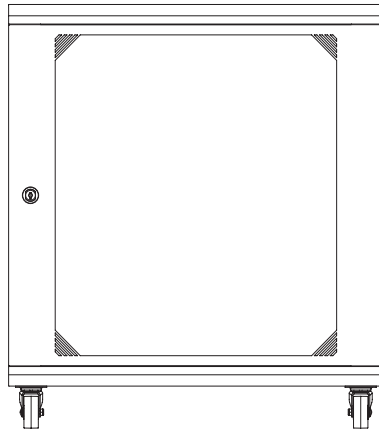
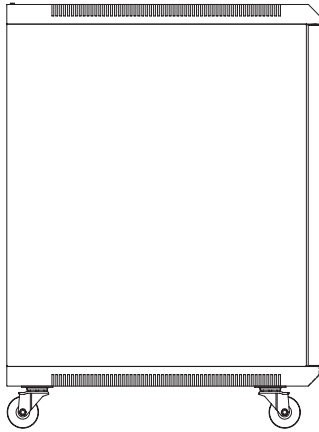
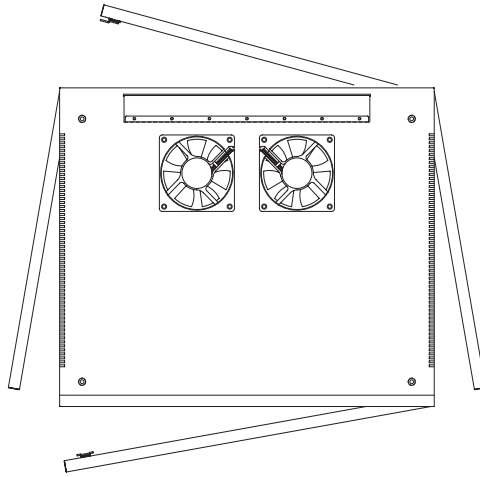

Dimension Table:

Total Unit(U)	12	13	14	15	16	17	18	19
Total Height (mm)	663.4	707.85	752.3	796.75	841.2	885.65	930.1	974.55
Width	600	600	600	600	600	600	600	600
Clearance Size (1U=44.45mm)	533.4	577.85	622.3	666.75	711.2	755.65	800.1	844.55
Model No.	CLM- 23260-12AB	23260-13AB	23260-14AB	23260-15AB	23260-16AB	23260-17AB	23260-18AB	23260-19AB
Depth =600	600	600	600	600	600	600	600	600
Shipping Dimension								
Complete	9.80	10.59	11.27	11.76	12.57	13.25	13.92	14.59
D.I.Y	3.99	4.36	4.63	4.67	5.19	5.47	5.75	6.09
G.W.								
Model No.	CLM- 23265-12AB	23265-13AB	23265-14AB	23265-15AB	23265-16AB	23265-17AB	23265-18AB	23265-19AB
Depth =650	● 650	650	650	650	650	650	● 650	650
Shipping Dimension								
Complete	10.56	11.41	12.14	12.67	13.54	14.26	14.99	15.72
D.I.Y	4.28	4.68	4.97	5.03	5.57	5.87	6.17	6.46
G.W.								
Model No.	CLM- 23270-12AB	23270-13AB	23270-14AB	23270-15AB	23270-16AB	23270-17AB	23270-18AB	23270-19AB
Depth =700	700	700	700	700	700	700	700	700
Shipping Dimension								
Complete	11.31	12.22	13.01	13.57	14.51	15.28	16.06	16.84
D.I.Y	4.58	5.00	5.31	5.39	5.95	6.27	6.59	6.90
G.W.								

Color choose : Fill number 5, 1 in the

5 - RAL7035

1 - RAL9011

CLM-232xx-xxAB 19" WALL-MOUNT Rack For Distributors & Under-Desk Mini Server Solutions



19" 232XX SERIES WALLMOUNT

Total Unit(U)	20	21	22	23	24
Total Height	1019	1063.45	1107.9	1152.35	1196.8
Width	600	600	600	600	600
Clearance Size (1U=44.45mm)	889	933.45	977.9	1022.35	1066.8
CLM-	23260-20AB	23260-21AB	23260-22AB	23260-23AB	23260-24AB
Depth =600	600	600	600	600	600
Dimension					
Complete	15.27	15.94	16.62	17.29	17.96
Complete	6.3	6.6	6.76	6.76	6.76
G.W.					
CLM-	23265-20AB	23265-21AB	23265-22AB	23265-23AB	23265-24AB
Depth =650	650	● 650	650	650	● 650
Shipping Dimension					
Complete	16.44	17.17	17.89	18.62	19.35
Complete	6.76	7.08	7.25	7.25	7.25
G.W.					
CLM-	23270-20AB	23270-21AB	23270-22AB	23270-23AB	23270-24AB
Depth =700	700	700	700	700	700
Shipping Dimension					
Complete	17.62	18.40	19.17	19.95	20.73
Complete	7.22	7.56	7.74	7.74	7.74
G.W.					

Color choose : Fill number 5, 1 in the

5 - RAL7035

1 - RAL9011

Component Parts	Num	Model No.
Roof Panel	1	882365
Bottom Panel	1	882366
Frame	1	882227
	1	882404
Vented Glass Door	1	882403
Side Panel	2	882226
Rear Door	1	882405
Castor	4	882350
Crossbeam	2	612537
M-shaped Piece	4	612641
F-shaped mounting angle	4	612615
Washers of F-shaped	8	612590
Fixer for F-shaped & frame	2	612752
Self-tapping Screw 12#24	40	662127
Self-tapping Screw O 4	16	662125
Self-tapping Screw M4	4	662035-06
Self-tapping Washer Screw	12	612009-12
Cage Nut M6	12	882003-06

CLM-23275-xxAB □

W600 X D700 X H(12U to 24U)

CLM-23280-xxAB □

W600 X D800 X H(12U to 24U)

CLM-23285-xxAB □

W600 X D850 X H(12U to 24U)

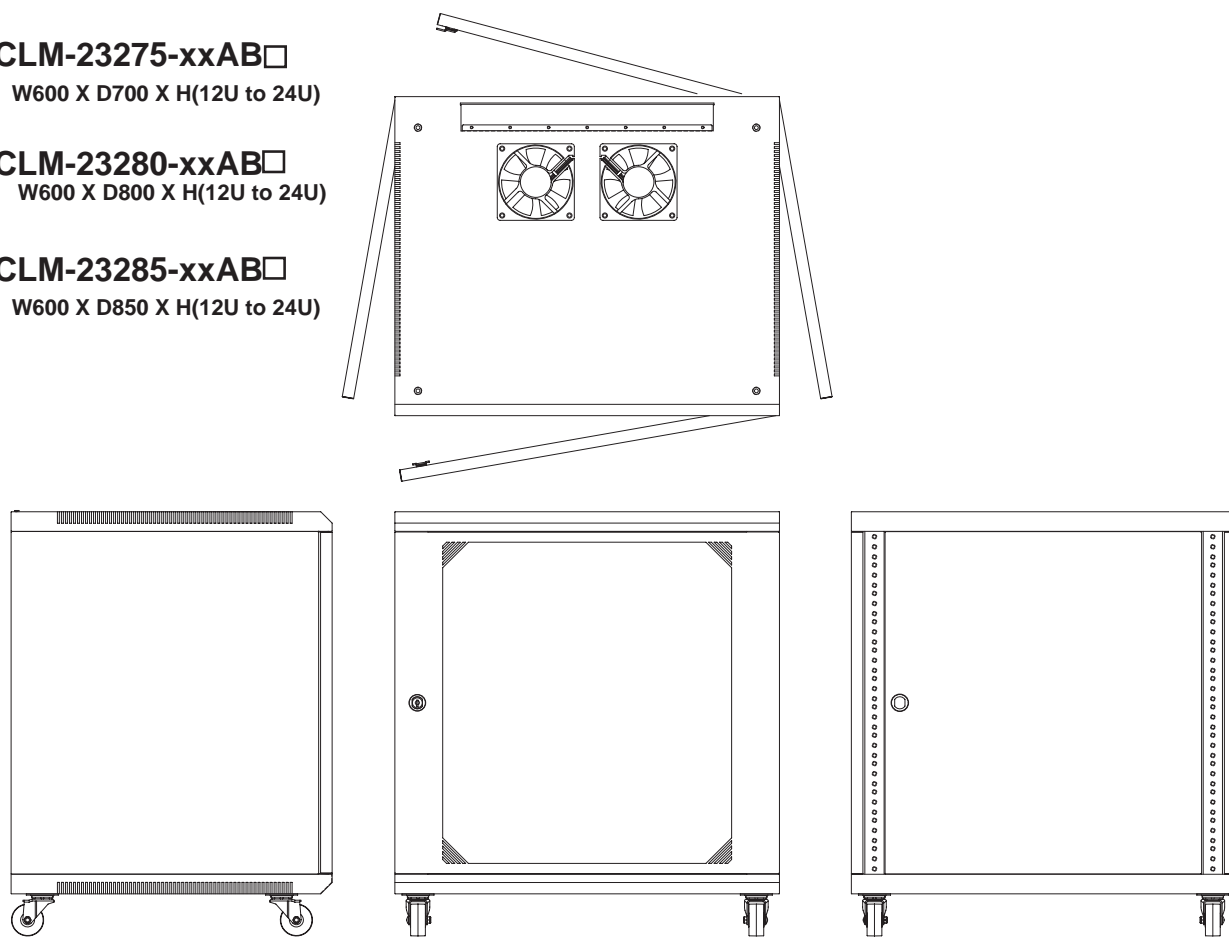

Dimension Table:

Total Unit(U)	12	13	14	15	16	17	18	19
Total Height (mm)	663.4	707.85	752.3	796.75	841.2	885.65	930.1	974.55
Width	600	600	600	600	600	600	600	600
Clearance Size (1U=44.45mm)	533.4	577.85	622.3	666.75	711.2	755.65	800.1	844.55
Model No.	CLM- 23275-12AB	23275-13AB	23275-14AB	23275-15AB	23275-16AB	23275-17AB	23275-18AB	23275-19AB
Depth =750	750	750	750	750	750	750	750	750
Shipping Dimension								
Complete	12.06	13.03	13.87	14.48	15.47	16.30	17.13	17.96
D.I.Y	4.88	5.32	5.64	5.74	6.33	6.66	7.01	7.34
G.W.								
Model No.	CLM- 23280-12AB	23280-13AB	23280-14AB	23280-15AB	23280-16AB	23280-17AB	23280-18AB	23280-19AB
Depth =800	800	800	800	800	800	800	800	800
Shipping Dimension								
Complete	12.82	13.85	14.74	15.38	16.44	17.32	18.20	19.09
D.I.Y	5.13	5.63	5.98	6.10	6.71	7.06	7.43	7.78
G.W.								
Model No.	CLM- 23285-12AB	23285-13AB	23285-14AB	23285-15AB	23285-16AB	23285-17AB	23285-18AB	23285-19AB
Depth =850	● 850	850	850	850	850	850	● 850	850
Shipping Dimension								
Complete	13.57	14.66	15.61	16.29	17.41	18.34	19.27	20.21
D.I.Y	5.47	5.95	6.32	6.46	7.09	7.46	7.85	8.22
G.W.								

Color choose : Fill number 5, 1 in the □

5 - RAL7035

1 - RAL9011

CLM-232xx-xxAB 19" WALL-MOUNT Rack For Distributors & Under-Desk Mini Server Solutions



19" 232XX SERIES WALLMOUNT

Total Unit(U)	20	21	22	23	24
Total Height	1019	1063.45	1107.9	1152.35	1196.8
Width	600	600	600	600	600
Clearance Size (1U=44.45mm)	889	933.45	977.9	1022.35	1066.8
CLM- Depth =750	23275-20AB	23275-21AB	23275-22AB	23275-23AB	23275-24AB
Dimension	750	750	750	750	750
Complete	18.79	19.62	20.45	21.28	22.11
Complete	7.68	8.04	8.23	8.23	8.23
G.W.					
CLM- Depth =800	23280-20AB	23280-21AB	23280-22AB	23280-23AB	23280-24AB
Shipping Dimension	800	800	800	800	800
Complete	19.97	20.65	21.73	22.61	23.49
Complete	8.14	8.52	8.72	8.72	8.72
G.W.					
CLM- Depth =850	23285-20AB	23285-21AB	23285-22AB	23285-23AB	23285-24AB
Shipping Dimension	850	850	850	850	850
Complete	21.14	22.07	23.01	23.94	24.88
Complete	8.60	9.01	9.22	9.22	9.22
G.W.					

Color choose : Fill number 5, 1 in the

5 - RAL7035

1 - RAL9011

Component Parts	Num	Model No.
Roof Panel	1	882365
Bottom Panel	1	882366
Frame	1	882227
	1	882404
Vented Glass Door	1	882403
Side Panel	2	882226
Rear Door	1	882405
Castor	4	882350
Crossbeam	2	612537
M-shaped Piece	4	612641
F-shaped mounting angle	4	612615
Washers of F-shaped	8	612590
Fixer for F-shaped & frame	2	612752
Self-tapping Screw 12#24	40	662127
Self-tapping Screw O 4	16	662125
Self-tapping Screw M4	4	662035-06
Self-tapping Washer Screw	12	612009-12
Cage Nut M6	12	882003-06

CLM-23230-xxAC □
W600 X D300 X H(6U to 24U)

CLM-23235-xxAC □
W600 X D350 X H(6U to 24U)

CLM-23240-xxAC □
W600 X D400 X H(6U to 24U)

CLM-23245-xxAC □
W600 X D450 X H(6U to 24U)

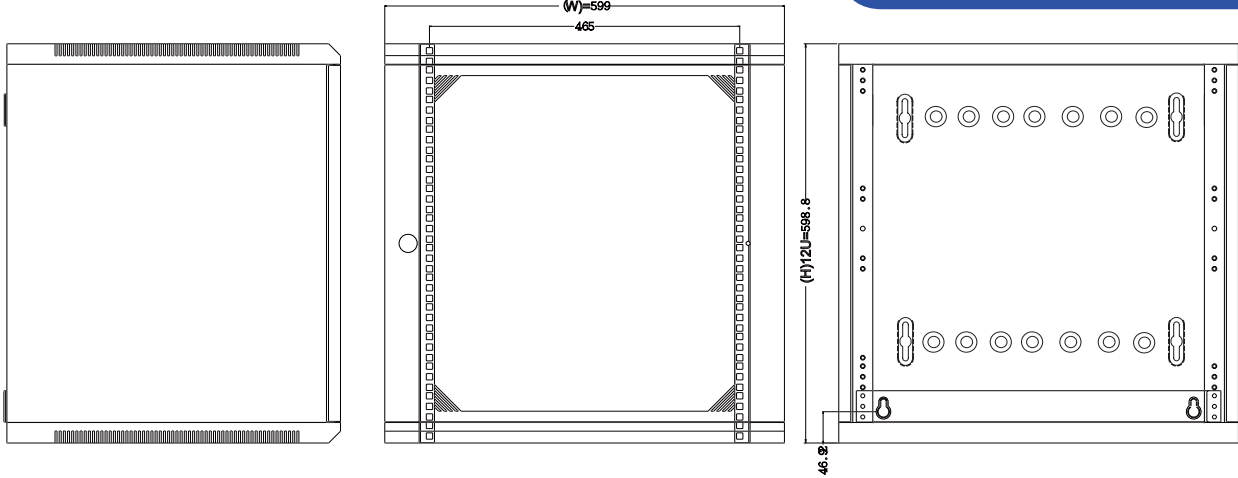
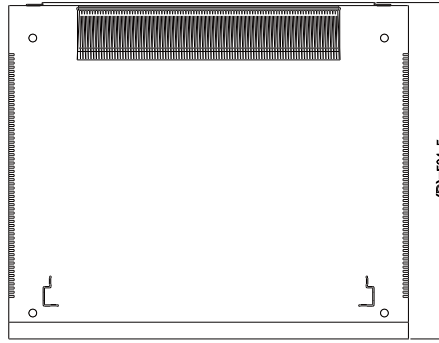

Component Parts	Num	Model No.
Roof Panel	1	882401
Bottom Panel	1	882402
Frame	2	882227
Vented Glass Door	1	882403
Side Panel	2	882226
Rear Panel	1	612773
Brush Strip	2	882364
F-shaped mounting angle	2	612615
Washers of F-shaped	4	612590
Fixer for F-shaped & frame	2	612752
Self-tapping Screw 12#24	33	662127
Self-tapping Screw M4	4	662035-06
Self-tapping Washer Screw	12	612009-12
Cage Nut M6	12	882003-06

Dimension Table:

Total Unit(U)	6	7	8	9	10	11	12	13	14
Total Height (mm)	330.70	375.15	419.60	464.05	508.50	552.95	597.40	641.85	686.3
Width	600	600	600	600	600	600	600	600	600
Clearance Size (1U=44.45mm)	266.7	311.15	355.6	400.05	444.5	488.95	533.4	577.85	622.3
Model No.	CLM- 23230-06AC	23230-07AC	23230-08AC	23230-09AC	23230-10AC	23230-11AC	23230-12AC	23230-13AC	23230-14AC
Depth =300	300	300	300	300	300	300	300	300	300
Shipping Dimension									
Complete	3.12	3.49	3.84	4.20	4.55	5.13	5.28	5.71	6.07
D.I.Y	1.92	2.23	2.69	2.69	2.7	2.71	2.75	3.12	3.17
G.W.									
Model No.	CLM- 23235-06AC	23235-07AC	23235-08AC	23235-09AC	23235-10AC	23235-11AC	23235-12AC	23235-13AC	23235-14AC
Depth =350	350	350	350	350	350	350	350	350	350
Shipping Dimension									
Complete	3.58	3.96	4.39	4.80	5.20	5.86	6.03	6.52	6.94
D.I.Y	2.19	2.43	2.57	2.86	3.13	3.41	3.12	3.34	3.54
G.W.									
Model No.	CLM- 23240-06AC	23240-07AC	23240-08AC	23240-09AC	23240-10AC	23240-11AC	23240-12AC	23240-13AC	23240-14AC
Depth =400	● 400	400	400	● 400	400	400	● 400	400	400
Shipping Dimension									
Complete	4.03	4.48	4.94	5.40	5.85	6.59	6.79	7.33	7.80
D.I.Y	2.45	2.83	2.83	3.05	3.13	3.41	3.67	4.25	3.79
G.W.									
Model No.	CLM- 23245-06AC	23245-07AC	23245-08AC	23245-09AC	23245-10AC	23245-11AC	23245-12AC	23245-13AC	23245-14AC
Depth =450	450	450	450	450	450	450	450	450	450
Shipping Dimension									
Complete	4.48	4.98	5.48	6.00	6.50	7.32	7.54	8.15	8.67
D.I.Y	2.72	3.05	3.14	3.36	3.36	3.39	3.67	4.25	4.65
G.W.									

Color choose : Fill number 5, 1 in the □

5 - RAL7035

1 - RAL9011

CLM-232xx-xxAC 19" WALL-MOUNT Rack

For Distributors & Under-Desk Mini Server Solutions



19" 232XX SERIES WALLMOUNT

Total Unit(U)	15	16	17	18	19	20	21	22	23	24
Total Height	730.75	775.2	819.65	864.1	908.55	953	997.45	1043.9	1086.35	1130.8
Width	600	600	600	600	600	600	600	600	600	600
Clearance Size (1U=44.45mm)	666.75	711.2	756.65	800.1	844.55	889	933.45	977.9	1022.35	1066.8
CLM-	23230-15AA	23230-16AA	23230-17AA	23230-18AA	23230-19AA	23230-20AA	23230-21AA	23230-22AA	23230-23AA	23230-24AA
Depth =300	300	300	300	300	300	300	300	300	300	300
Dimension										
Complete	6.33	6.77	7.14	7.50	7.86	8.23	8.59	8.95	9.32	9.68
Complete	3.31	3.78	3.95	4.15	4.35	4.55	4.75	4.95	5.15	5.35
G.W.										
CLM-	23235-15AA	23235-16AA	23235-17AA	23235-18AA	23235-19AA	23235-20AA	23235-21AA	23235-22AA	23235-23AA	23235-24AA
Depth =350	350	350	350	350	350	350	350	350	350	350
Shipping Dimension										
Complete	7.24	7.74	8.15	8.57	8.98	9.40	9.81	10.23	10.64	11.06
Complete	3.56	3.97	3.97	4.4	4.37	4.57	4.77	4.97	5.18	5.38
G.W.										
CLM-	23240-15AA	23240-16AA	23240-17AA	23240-18AA	23240-19AA	23240-20AA	23240-21AA	23240-22AA	23240-23AA	23240-24AA
Depth =400	400	400	400	400	400	400	400	400	400	400
Shipping Dimension										
Complete	8.14	8.70	9.17	9.64	10.10	10.57	11.03	11.50	11.97	12.43
Complete	4.64	4.23	4.24	4.69	4.67	4.89	5.1	5.32	5.54	5.75
G.W.										
CLM-	23245-15AA	23245-16AA	23245-17AA	23245-18AA	23245-19AA	23245-20AA	23245-21AA	23245-22AA	23245-23AA	23245-24AA
Depth =450	450	450	450	450	450	450	450	450	450	450
Shipping Dimension										
Complete	9.05	9.67	10.19	10.71	11.23	11.75	12.26	12.78	13.30	13.82
Complete	4.91	5.21	5.49	5.2	5.24	5.48	5.72	5.96	6.21	6.45
G.W.										

Color choose : Fill number 5, 1 in the

5 - RAL7035

1 - RAL9011

CLM-23250-xxAC □
W600 X D500 X H(6U to 24U)

CLM-23255-xxAC □
W600 X D550 X H(6U to 24U)

CLM-23260-xxAC □
W600 X D600 X H(6U to 24U)

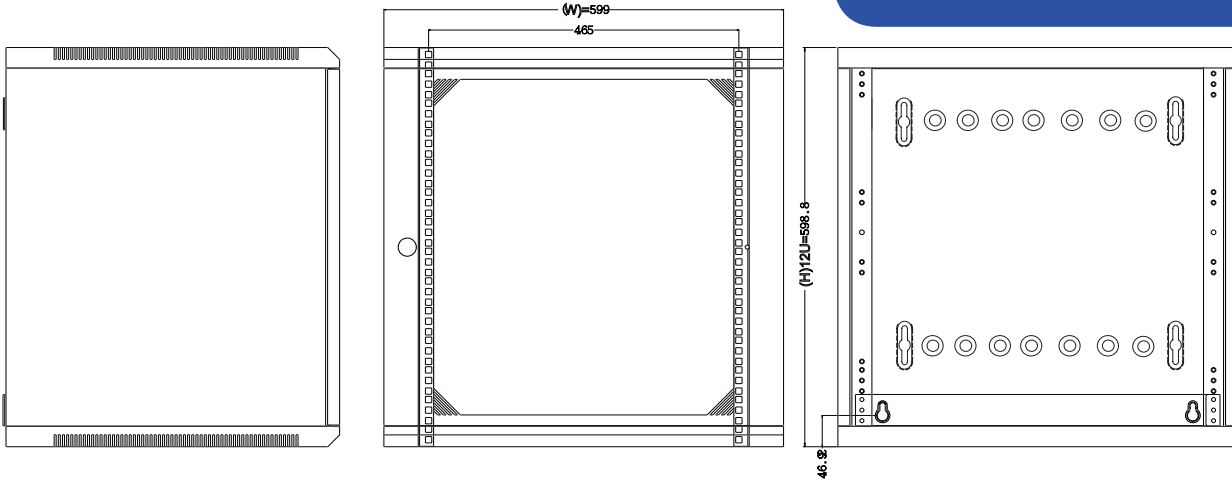
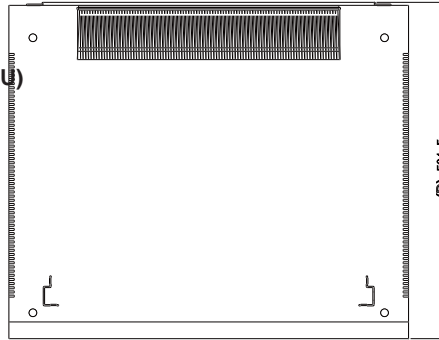

Component Parts	Num	Model No.
Roof Panel	1	882401
Bottom Panel	1	882402
Frame	2	882227
Vented Glass Door	1	882403
Side Panel	2	882226
Rear Panel	1	612773
Brush Strip	2	882364
F-shaped mounting angle	2	612615
Washers of F-shaped	4	612590
Fixer for F-shaped & frame	2	612752
Self-tapping Screw 12#24	33	662127
Self-tapping Screw M4	4	662035-06
Self-tapping Washer Screw	12	612009-12
Cage Nut M6	12	882003-06

Dimension Table:

Total Unit(U)	6	7	8	9	10	11	12	13	14
Total Height (mm)	330.70	375.15	419.60	464.05	508.50	552.95	597.40	641.85	686.3
Width	600	600	600	600	600	600	600	600	600
Clearance Size (1U=44.45mm)	266.7	311.15	355.6	400.05	444.5	488.95	533.4	577.85	622.3
Model No. CLM-	23250-06AC	23250-07AC	23250-08AC	23250-09AC	23250-10AC	23250-11AC	23250-12AC	23250-13AC	23250-14AC
Depth =500	● 500	500	500	● 500	500	500	● 500	500	500
Shipping Dimension									
Complete	4.93	5.48	6.03	6.60	7.15	8.05	8.29	8.96	9.53
D.I.Y	2.99	3.35	3.46	3.46	3.67	3.68	3.68	4.25	4.65
G.W.									
Model No. CLM-	23255-06AC	23255-07AC	23255-08AC	23255-09AC	23255-10AC	23255-11AC	23255-12AC	23255-13AC	23255-14AC
Depth =550	550	550	550	550	550	550	550	550	550
Shipping Dimension									
Complete	5.37	5.98	6.56	7.20	7.80	8.79	9.05	9.78	10.41
D.I.Y	2.91	3.65	3.77	3.77	3.78	3.89	3.98	4.25	4.65
G.W.									
Model No. CLM-	23260-06AC	23260-07AC	23260-08AC	23260-09AC	23260-10AC	23260-11AC	23260-12AC	23260-13AC	23260-14AC
Depth =600	600	600	600	600	600	600	600	600	600
Shipping Dimension									
Complete	5.82	6.47	7.13	7.80	8.45	9.52	9.80	10.59	11.27
D.I.Y	3.15	3.96	4.08	4.08	4.09	4.11	4.19	4.58	4.86
G.W.									

Color choose : Fill number 5, 1 in the □
 5 - RAL7035
 1 - RAL9011

CLM-232xx-xxAC 19" WALL-MOUNT Rack

For Distributors & Under-Desk Mini Server Solutions



19" 232XX SERIES WALLMOUNT

Total Unit(U)	15	16	17	18	19	20	21	22	23	24
Total Height	730.75	775.2	819.65	864.1	908.55	953	997.45	1043.9	1086.35	1130.8
Width	600	600	600	600	600	600	600	600	600	600
Clearance Size (1U=44.45mm)	666.75	711.2	756.65	800.1	844.55	889	933.45	977.9	1022.35	1066.8
CLM-	23250-15AA	23250-16AA	23250-17AA	23250-18AA	23250-19AA	23250-20AA	23250-21AA	23250-22AA	23250-23AA	23250-24AA
Depth =500	● 500	500	500	● 500	500	500	● 500	500	500	500
Dimension										
Complete	9.95	10.63	11.20	11.77	12.34	12.91	13.48	14.05	14.62	15.19
Complete	4.91	5.21	5.48	5.77	5.74	5.74	5.74	5.96	6.12	6.45
G.W.										
CLM-	23255-15AA	23255-16AA	23255-17AA	23255-18AA	23255-19AA	23255-20AA	23255-21AA	23255-22AA	23255-23AA	23255-24AA
Depth =550	550	550	550	550	550	550	550	550	550	550
Shipping Dimension										
Complete	10.86	11.61	12.23	12.85	13.48	14.10	14.72	15.34	15.97	16.59
Complete	4.91	5.21	5.49	5.77	6.04	6.32	6.59	6.28	6.28	6.45
G.W.										
CLM-	23260-15AA	23260-16AA	23260-17AA	23260-18AA	23260-19AA	23260-20AA	23260-21AA	23260-22AA	23260-23AA	23260-24AA
Depth =600	600	600	600	600	600	600	600	600	600	600
Shipping Dimension										
Complete	11.76	12.57	13.25	13.92	14.59	15.27	15.94	16.62	17.29	17.96
Complete	4.91	5.46	5.74	6.04	6.33	6.62	6.93	7.15	7.15	7.15
G.W.										

Color choose : Fill number 5, 1 in the

5 - RAL7035

1 - RAL9011

Roof & Bottom Panel Variants

For 232-AX

Vented Bevel Roof & Bottom Panel (882228-xx)



Feature :

The 30.7mm height roof & bottom panel vented skirt slots on right and left side can get a good ventilation on the top & bottom and it can be set brush-strips on as cable entry.

Dimensions :

Width : 19"(600mm)

Depth : 250mm,300mm,350mm,400mm,450mm,500mm,550mm,600mm

Option for Fans : No .

Finished : Powder coating in RAL7035 & RAL9011.

Material : Sheet steel.

Lenght (mm)	Width (mm)	CLM Part No.	For Model No.	Fan(CLM-882138) Number
250	600	882228-625	CLM-232xx AA type	No
300	600	882228-630	CLM-232xx AA type	No
350	600	882228-635	CLM-232xx AA type	No
400	600	882228-640	CLM-232xx AA type	No
450	600	882228-645	CLM-232xx AA type	No
500	600	882228-650	CLM-232xx AA type	No
550	600	882228-655	CLM-232xx AA type	No
600	600	882228-660	CLM-232xx AA type	No

Color choose : Fill number 5, 1 in the

5 - RAL7035

1 - RAL9011

Vented Bevel Roof Panel With 2 Fan-kits (882365-xx)

882365-6xx



882365-6xx(With 2 Fans)



Feature :

The 30.7mm height roof & bottom panel vented skirt slots on right and left side can get a good ventilation on the top & bottom and it can be set a foam-rubber on as a cable entry. It can be optional for two fans for better ventilation .

Dimensions : 600mm , 650mm , 700mm , 750mm , 800mm ,850mm

Option for Fans : Yes.

Finished : Powder coating in RAL7035 & RAL9011.

Material : Sheet steel.

Lenght (mm)	Width (mm)	CLM Part No.	For Model No.	Fan(CLM-882138) Number
600	600	882365-660	CLM-232xx AB type	Max to 2
650	600	882365-665	CLM-232xx AB type	Max to 2
700	600	882365-670	CLM-232xx AB type	Max to 2
750	600	882365-675	CLM-232xx AB type	Max to 2
800	600	882365-680	CLM-232xx AB type	Max to 2
850	600	882365-685	CLM-232xx AB type	Max to 2

Color choose : Fill number 5, 1 in the

5 - RAL7035

1 - RAL9011

Vented Bevel Bottom Panel (882366-xx)

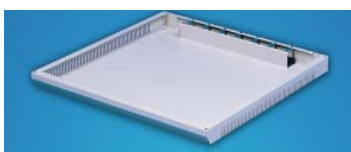

Feature :

The 30.7mm height roof & bottom panel vented skirt slots on right and left side to get a good ventilation on the top and it can be set optional a foam-rubber on as a cable entry.

Dimensions :

Width : 19"(600mm)

Depth : 600mm , 650mm , 700mm , 750mm , 800mm ,850mm

Option for Fans : No .

Finished : Powder coating in RAL7035 & RAL9011.

Material : Sheet steel.

Lenght (mm)	Width (mm)	CLM Part No.	For Model No.	Fan(CLM-882138) Number
600	600	882366-660	CLM-232xx AB type	No
650	600	882366-665	CLM-232xx AB type	No
700	600	882366-670	CLM-232xx AB type	No
750	600	882366-675	CLM-232xx AB type	No
800	600	882366-680	CLM-232xx AB type	No
850	600	882366-685	CLM-232xx AB type	No

Color choose : Fill number 5, 1 in the

5 - RAL7035

1 - RAL9011

Roof & Bottom Panel Variants

For 232-AC

Vented Bevel Roof Panel With 2 Fan-kits (882401-6xx)



Feature :

The 30.7mm height roof & bottom panel vented skirt slots on right and left side can get a good ventilation on the top & bottom and it can be set a sponge on as a cable entry. It can be optional for two fans for better ventilation .

Dimension :

Depth : 300mm , 350mm , 400mm , 450mm , 500mm , 550mm , 600mm

Option for Fans : Yes.

Finished : Powder coating in RAL7035 & RAL9011.

Material : Sheet steel.

Lenght (mm)	Width (mm)	CLM Part No.	For Model No.	Fan(CLM-882138) Number
300	600	882401-630	CLM-232xx AC type	Max to 2
350	600	882401-635	CLM-232xx AC type	Max to 2
400	600	882401-640	CLM-232xx AC type	Max to 2
450	600	882401-645	CLM-232xx AC type	Max to 2
500	600	882401-650	CLM-232xx AC type	Max to 2
550	600	882401-655	CLM-232xx AC type	Max to 2
600	600	882401-660	CLM-232xx AC type	Max to 2

Color choose : Fill number 5, 1 in the

5 - RAL7035

1 - RAL9011

Roof Panel with 2 fans



Sample



Finished

Operations for setting two fans on the roof panel

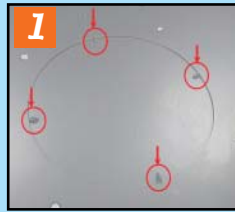

1 Find out convex points



2 To cut 4 convex points off.



3 To appear an empty fan-hole for setting a fan



4 To put fan screw penetrate the fan guard and roof panel



5 To insert fan into screw on Roof panel .



6 To fix the screw-Nut tightly .

19" 232XX SERIES WALLMOUNT

Vented Bevel Bottom Panel (882402-6xx)

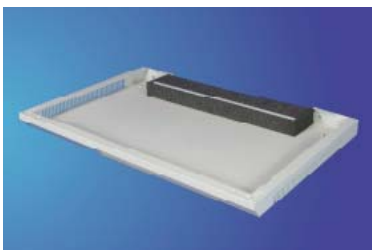

Feature :

The 30.7mm height roof & bottom panel vented skirt slots on right and left side can get a good ventilation on the top & bottom and it can be set sponge on as cable entry.

Dimension :

Depth : 300mm , 350mm , 400mm , 450mm , 500mm , 550mm , 600mm

Option for Fans : No

Finished : Powder coating in RAL7035 & RAL9011.

Material : Sheet steel.

Lenght (mm)	Width (mm)	CLM Part No.	For Model No.	Fan(CLM-882138) Number
300	600	882402-630	CLM-232xx AC type	No
350	600	882402-635	CLM-232xx AC type	No
400	600	882402-640	CLM-232xx AC type	No
450	600	882402-645	CLM-232xx AC type	No
500	600	882402-650	CLM-232xx AC type	No
550	600	882402-655	CLM-232xx AC type	No
600	600	882402-660	CLM-232xx AC type	No

Color choose : Fill number 5, 1 in the

5 - RAL7035

1 - RAL9011

Front Door Variants

For 232-AX

Vented Tempered Glass Door (882403-6xx)



Spring-load hinge



Feature :

A 3.0mm single-pane tempered glass is attached to flat & vented sheet steel panel for a window maximum view of components in the cabinet equipment with 2 spring-loaded hinges while putting it into the roof & bottom panels to fix it, to pull-down from the main frame can take off with cycle lock protecting all components in the cabinet. The vented slots can increase the ventilation of cabinet / rack.

It's a flexible open-way direction to right or left side based on to working environment removable.

Dimensions :

Width : 600 mm
Height : 4U~24U

Material : Thickness sheet steel & tempered glasses & assembly parts.

Finished :

Powder coating in RAL7035&RAL9011

Height (u)	Width (mm)	CLM Part No.
4U	600	882403-604
5U	600	882403-605
6U	600	882403-606
7U	600	882403-607
8U	600	882403-608
9U	600	882403-609
10U	600	882403-610
11U	600	882403-611
12U	600	882403-612
13U	600	882403-613
14U	600	882403-614
15U	600	882403-615
16U	600	882403-616
17U	600	882403-617
18U	600	882403-618
19U	600	882403-619
20U	600	882403-620
21U	600	882403-621
22U	600	882403-622
23U	600	882403-623
24U	600	882403-624

Color choose : Fill number 5, 1 in the

5 - RAL7035

1 - RAL9011

19" 232XX SERIES WALLMOUNT

Tempered Glass Door (882225-6xx)



Spring-load hinge



Feature :

A 3.0mm single-pane tempered glass is attached to flat & vented sheet steel panel for a window maximum view of components in the cabinet equipment with 2 spring-loaded hinges while putting it into the roof & bottom panels to fix it, to pull-down from the main frame can take off with cycle lock protecting all components in the cabinet.

It's a flexible open-way direction to right or left side based on to working environment removable.

Dimensions :

Width : 600 mm
Height : 4U~24U

Material : Thickness sheet steel & tempered glasses & assembly parts.

Finished :

Powder coating in RAL7035&RAL9011

Height (u)	Width (mm)	CLM Part No.
4U	600	882225-604
5U	600	882225-605
6U	600	882225-606
7U	600	882225-607
8U	600	882225-608
9U	600	882225-609
10U	600	882225-610
11U	600	882225-611
12U	600	882225-612
13U	600	882225-613
14U	600	882225-614
15U	600	882225-615
16U	600	882225-616
17U	600	882225-617
18U	600	882225-618
19U	600	882225-619
20U	600	882225-620
21U	600	882225-621
22U	600	882225-622
23U	600	882225-623
24U	600	882225-624

Color choose : Fill number 5, 1 in the

5 - RAL7035

1 - RAL9011

Front Door & Main Frame

For 232-AX

Mesh Vented Front Door (882356-6xx)



Feature :

A vented mesh holes facilitate a high air-flow throughout whole cabinet to keep uninterrupted operation at a constant temperature as well as ensuring adequate ventilation.

A single-panel is punching with Ø 6mm concentrated holes to create effective over 82% heat dissipation for optimum server environment for protecting all installed hardware and software components without shutting-down.

Dimensions :

Width : 600mm

Height : 4U~24U

Material :

Thickness sheet steel & assembly parts.

Finished :

Powder coating in RAL7035&RAL9011

Height (u)	Width (mm)	CLM Part No.
4U	600	882356-604
5U	600	882356-605
6U	600	882356-606
7U	600	882356-607
8U	600	882356-608
9U	600	882356-609
10U	600	882356-610
11U	600	882356-611
12U	600	882356-612
13U	600	882356-613
14U	600	882356-614
15U	600	882356-615
16U	600	882356-616
17U	600	882356-617
18U	600	882356-618
19U	600	882356-619
20U	600	882356-620
21U	600	882356-621
22U	600	882356-622
23U	600	882356-623
24U	600	882356-624

Color choose : Fill number 5, 1 in the

5 - RAL7035

1 - RAL9011

Main Frames (882227-xxxx)



Feature :

Construction of specific square welding iron-design is designed by CLM. It can construct with firmly structure. Each horizontally metric and vertically inch pitch is manufactured clearly for mounting accessories. These holes in front can provide with the management of cable for integrated and quick-searched.

Dimensions :

Depth : 250mm , 300mm , 350mm , 400mm , 450mm , 500mm , 550mm , 600mm , 650mm , 700mm , 750mm , 800mm , 850mm

Height : 4U~24U

Material : Thickness sheet steel.

Finished : Powder coating in RAL7035or RAL 9011.

CLM Part No.	Depth 250mm	Depth 300mm	Depth 350mm	Depth 400mm	Depth 450mm	Depth 500mm	Depth 550mm	Depth 600mm
4U	882227-2504	882227-3004	882227-3504	882227-4004	882227-4504	882227-5004	882227-5504	882227-6004
5U	882227-2505	882227-3005	882227-3505	882227-4005	882227-4505	882227-5005	882227-5505	882227-6005
6U	882227-2506	882227-3006	882227-3506	882227-4006	882227-4506	882227-5006	882227-5506	882227-6006
7U	882227-2507	882227-3007	882227-3507	882227-4007	882227-4507	882227-5007	882227-5507	882227-6007
8U	882227-2508	882227-3008	882227-3508	882227-4008	882227-4508	882227-5008	882227-5508	882227-6008
9U	882227-2509	882227-3009	882227-3509	882227-4009	882227-4509	882227-5009	882227-5509	882227-6009
10U	882227-2510	882227-3010	882227-3510	882227-4010	882227-4510	882227-5010	882227-5510	882227-6010
11U	882227-2511	882227-3011	882227-3511	882227-4011	882227-4511	882227-5011	882227-5511	882227-6011
12U	882227-2512	882227-3012	882227-3512	882227-4012	882227-4512	882227-5012	882227-5512	882227-6012
13U	882227-2513	882227-3013	882227-3513	882227-4013	882227-4513	882227-5013	882227-5513	882227-6013
14U	882227-2514	882227-3014	882227-3514	882227-4014	882227-4514	882227-5014	882227-5514	882227-6014
15U	882227-2515	882227-3015	882227-3515	882227-4015	882227-4515	882227-5015	882227-5515	882227-6015
16U	882227-2516	882227-3016	882227-3516	882227-4016	882227-4516	882227-5016	882227-5516	882227-6016
17U	882227-2517	882227-3017	882227-3517	882227-4017	882227-4517	882227-5017	882227-5517	882227-6017
18U	882227-2518	882227-3018	882227-3518	882227-4018	882227-4518	882227-5018	882227-5518	882227-6018
19U	882227-2519	882227-3019	882227-3519	882227-4019	882227-4519	882227-5019	882227-5519	882227-6019
20U	882227-2520	882227-3020	882227-3520	882227-4020	882227-4520	882227-5020	882227-5520	882227-6020
21U	882227-2521	882227-3021	882227-3521	882227-4021	882227-4521	882227-5021	882227-5521	882227-6021
22U	882227-2522	882227-3022	882227-3522	882227-4022	882227-4522	882227-5022	882227-5522	882227-6022
23U	882227-2523	882227-3023	882227-3523	882227-4023	882227-4523	882227-5023	882227-5523	882227-6023
24U	882227-2524	882227-3024	882227-3524	882227-4024	882227-4524	882227-5024	882227-5524	882227-6024

Color choose : Fill number 5, 1 in the

5 - RAL7035

1 - RAL9011

Main Frames Variants

For 232-AX

Main Frames (882227-xxxx)



CLM Part No.	Width 650mm	Width 700mm	Width 750mm	Width 800mm	Width 850mm
4U	882227-6504	882227-7004	882227-7504	882227-8004	882227-8504
5U	882227-6505	882227-7005	882227-7505	882227-8005	882227-8505
6U	882227-6506	882227-7006	882227-7506	882227-8006	882227-8506
7U	882227-6507	882227-7007	882227-7507	882227-8007	882227-8507
8U	882227-6508	882227-7008	882227-7508	882227-8008	882227-8508
9U	882227-6509	882227-7009	882227-7509	882227-8009	882227-8509
10U	882227-6510	882227-7010	882227-7510	882227-8010	882227-8510
11U	882227-6511	882227-7011	882227-7511	882227-8011	882227-8511
12U	882227-6512	882227-7012	882227-7512	882227-8012	882227-8512
13U	882227-6513	882227-7013	882227-7513	882227-8013	882227-8513
14U	882227-6514	882227-7014	882227-7514	882227-8014	882227-8514
15U	882227-6515	882227-7015	882227-7515	882227-8015	882227-8515
16U	882227-6516	882227-7016	882227-7516	882227-8016	882227-8516
17U	882227-6517	882227-7017	882227-7517	882227-8017	882227-8517
18U	882227-6518	882227-7018	882227-7518	882227-8018	882227-8518
19U	882227-6519	882227-7019	882227-7519	882227-8019	882227-8519
20U	882227-6520	882227-7020	882227-7520	882227-8020	882227-8520
21U	882227-6521	882227-7021	882227-7521	882227-8021	882227-8521
22U	882227-6522	882227-7022	882227-7522	882227-8022	882227-8522
23U	882227-6523	882227-7023	882227-7523	882227-8023	882227-8523
24U	882227-6524	882227-7024	882227-7524	882227-8024	882227-8524

Color choose : Fill number 5, 1 in the

5 - RAL7035

1 - RAL9011

19" 232XX SERIES WALLMOUNT

Main Frame with Rear Door Kit (882404-xxxx)



Feature :

Construction of specific square welding iron-design is designed by CLM. It can construct with firmly structure . Each horizontally metric and vertically inch pitch is manufactured clearly for mounting accessories. These holes in front can provide with the management of cable for integrated and quick-searched. The rear of frame is combined with a bracket for locking the rear door.

Dimensions :

Depth : 600mm , 650mm , 700mm , 750mm , 800mm , 850mm

Height : 12U~24U

Material : Thickness sheet steel.

Finished : Powder coating in RAL7035or RAL 9011.

CLM Part No.	Width 600mm	Width 650mm	Width 700mm	Width 750mm	Width 800mm	Width 850mm	For Model No.
12U	882404-6012	882404-6512	882404-7012	882404-7512	882404-8012	882404-8512	CLM-232xx AB Type
13U	882404-6013	882404-6513	882404-7013	882404-7513	882404-8013	882404-8513	CLM-232xx AB Type
14U	882404-6014	882404-6514	882404-7014	882404-7514	882404-8014	882404-8514	CLM-232xx AB Type
15U	882404-6015	882404-6515	882404-7015	882404-7515	882404-8015	882404-8515	CLM-232xx AB Type
16U	882404-6016	882404-6516	882404-7016	882404-7516	882404-8016	882404-8516	CLM-232xx AB Type
17U	882404-6017	882404-6517	882404-7017	882404-7517	882404-8017	882404-8517	CLM-232xx AB Type
18U	882404-6018	882404-6518	882404-7018	882404-7518	882404-8018	882404-8518	CLM-232xx AB Type
19U	882404-6019	882404-6519	882404-7019	882404-7519	882404-8019	882404-8519	CLM-232xx AB Type
20U	882404-6020	882404-6520	882404-7020	882404-7520	882404-8020	882404-8520	CLM-232xx AB Type
21U	882404-6021	882404-6521	882404-7021	882404-7521	882404-8021	882404-8521	CLM-232xx AB Type
22U	882404-6022	882404-6522	882404-7022	882404-7522	882404-8022	882404-8522	CLM-232xx AB Type
23U	882404-6023	882404-6523	882404-7023	882404-7523	882404-8023	882404-8523	CLM-232xx AB Type
24U	882404-6024	882404-6524	882404-7024	882404-7524	882404-8024	882404-8524	CLM-232xx AB Type

Color choose : Fill number 5, 1 in the

5 - RAL7035

1 - RAL9011

Steady Bar & Rear Door

For 232-AB

Steady Bar (CLM-612537)

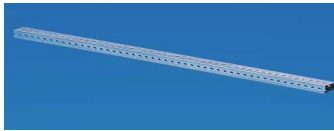

Assembled Position



Feature :

Construction of specific square welding iron-design is designed by CLM. Its position is front of main frame for more stable cabinet.

Operation :

By M-shaped fixer & screw, fix the steady bars on the top & bottom of main frame .

Material : Thickness sheet steel.

Finished : Powder coating in RAL7035&RAL9011

CLM Part No.	Assembled With	For Model No.	Quantity
612537-xx	612641-00	CLM-232xx AB Type	2

Color choose : Fill number 5, 1 in the

5 - RAL7035

1 - RAL9011

Operations



612641-00
M-shaped Fixer

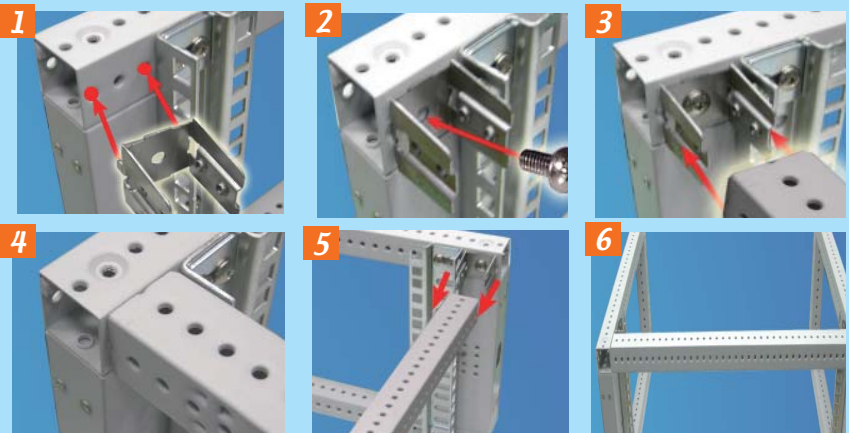

Rear Door (882405-xx)



Assembled Position



Feature :

A swing flexible, removable design is up to working environment to select a open direction on right or left side to set a better location without any problem. It with 4 cushions of rubber protect all of installation components.

Operation :

Whilst simple pull-down the spring loaded pins to do a adjust into the hole on the roof&bottom panels then to mount the door on the cabinet.

Dimensions :

Height : 12U ~ 24U

Material : Thickness sheet steel.

Finished : Powder coating in RAL7035or RAL 9011.

Height (U)	Width (mm)	CLM Part No.	For Model No.
12U	600	882405-12	CLM-232xx AB Type
13U	600	882405-13	CLM-232xx AB Type
14U	600	882405-14	CLM-232xx AB Type
15U	600	882405-15	CLM-232xx AB Type
16U	600	882405-16	CLM-232xx AB Type
17U	600	882405-17	CLM-232xx AB Type
18U	600	882405-18	CLM-232xx AB Type
19U	600	882405-19	CLM-232xx AB Type
20U	600	882405-20	CLM-232xx AB Type
21U	600	882405-21	CLM-232xx AB Type
22U	600	882405-22	CLM-232xx AB Type
23U	600	882405-23	CLM-232xx AB Type
24U	600	882405-24	CLM-232xx AB Type

Color choose : Fill number 5, 1 in the

5 - RAL7035

1 - RAL9011

Rear Parts & Cable Entry

For 232-AX

Wall bar (612613)



Feature :

A strengthened stamping heavy plate to provide for stability with heavy load capacity.

Material : Thickness Sheet Steel.

Finished : Zinc-Plated.

CLM Part No.	Height (U)	For Model No.	Quantity
612613-02	1U	CLM-232xx AA Type	2

Wall Panel (612773-xx)



Feature :

It protect from the dust or any damage of outside and provide many holes for fixing the ring of cable management "CLM-612199".

Dimensions :

Width : 600mm
Height : 6U~24U

Material : Thickness sheet steel.

Finished :
Powder coating in RAL7035 & RAL9011

Height (U)	Width (mm)	CLM Part No.	For Model No.
6	600	612773-606	CLM-232xx AC Type
7	600	612773-607	CLM-232xx AC Type
8	600	612773-608	CLM-232xx AC Type
9	600	612773-609	CLM-232xx AC Type
10	600	612773-610	CLM-232xx AC Type
11	600	612773-611	CLM-232xx AC Type
12	600	612773-612	CLM-232xx AC Type
13	600	612773-613	CLM-232xx AC Type
14	600	612773-614	CLM-232xx AC Type
15	600	612773-615	CLM-232xx AC Type
16	600	612773-616	CLM-232xx AC Type
17	600	612773-617	CLM-232xx AC Type
18	600	612773-618	CLM-232xx AC Type
19	600	612773-619	CLM-232xx AC Type
20	600	612773-620	CLM-232xx AC Type
21	600	612773-621	CLM-232xx AC Type
22	600	612773-622	CLM-232xx AC Type
23	600	612773-623	CLM-232xx AC Type
24	600	612773-624	CLM-232xx AC Type

Color choose : Fill number 5, 1 in the

5 - RAL7035

1 - RAL9011

19" 232XX SERIES WALLMOUNT

Brush Strip (882364) for Cable Entry and aguniss dust



The brush strips may be used for convenient cable entry and against dust coming into the cabinet. These may be fitted in numerous configurations. It's optional parts for roof panel & plinth.

Material: Plastic

- 2 CLM-512004 plastic strips
- CLM-512005 Brush strips

CLM Part No.	width (mm)	Length	For Model No.
882364-3960	390	60	CLM-232xx AX Type

Sponge (511043) for Cable Entry and aguniss dust



The Matt may be used for convenient cable entry and against dust coming into the cabinet. These may be fitted in numerous configurations. It's optional parts for roof panel & plinth.

Material: Matt

CLM Part No.	width (mm)	Length	For Model No.
511043-00	390	60	CLM-232xx AB/AC Type

Side Panel

For 232-AX

Side Panel (882226-xxxx)



Side Latch to hole

spring-loaded pin

Feature :

A swing flexible,removable design is up to working environment to select a open direction on right or left side to set a better location without any problem.It with 4 cushions of rubber protect all of installation components.

Operation :

Whilst simple pull-down the spring loaded pins to do a adjust into the hole on the roof & bottom panels then to mount the door on the cabinet.

Dimensions :

Depth : 250mm , 300mm , 350mm , 400mm , 450mm , 500mm , 550mm , 600mm , 650mm
700 mm , 750 mm , 800mm , 850mm

Height : 4U~24U

Material : Thickness sheet steel.

Finished : Powder coating in RAL7035or RAL 9011.

CLM Part No. Height	Width 250mm	Width 300mm	Width 350mm	Width 400mm	Width 450mm	Width 500mm	Width 550mm	Width 600mm
4U	882226-2504	882226-3004	882226-3504	882226-4004	882226-4504	882226-5004	882226-5504	882226-6004
5U	882226-2505	882226-3005	882226-3505	882226-4005	882226-4505	882226-5005	882226-5505	882226-6005
6U	882226-2506	882226-3006	882226-3506	882226-4006	882226-4506	882226-5006	882226-5506	882226-6006
7U	882226-2507	882226-3007	882226-3507	882226-4007	882226-4507	882226-5007	882226-5507	882226-6007
8U	882226-2508	882226-3008	882226-3508	882226-4008	882226-4508	882226-5008	882226-5508	882226-6008
9U	882226-2509	882226-3009	882226-3509	882226-4009	882226-4509	882226-5009	882226-5509	882226-6009
10U	882226-2510	882226-3010	882226-3510	882226-4010	882226-4510	882226-5010	882226-5510	882226-6010
11U	882226-2511	882226-3011	882226-3511	882226-4011	882226-4511	882226-5011	882226-5511	882226-6011
12U	882226-2512	882226-3012	882226-3512	882226-4012	882226-4512	882226-5012	882226-5512	882226-6012
13U	882226-2513	882226-3013	882226-3513	882226-4013	882226-4513	882226-5013	882226-5513	882226-6013
14U	882226-2514	882226-3014	882226-3514	882226-4014	882226-4514	882226-5014	882226-5514	882226-6014
15U	882226-2515	882226-3015	882226-3515	882226-4015	882226-4515	882226-5015	882226-5515	882226-6015
16U	882226-2516	882226-3016	882226-3516	882226-4016	882226-4516	882226-5016	882226-5516	882226-6016
17U	882226-2517	882226-3017	882226-3517	882226-4017	882226-4517	882226-5017	882226-5517	882226-6017
18U	882226-2518	882226-3018	882226-3518	882226-4018	882226-4518	882226-5018	882226-5518	882226-6018
19U	882226-2519	882226-3019	882226-3519	882226-4019	882226-4519	882226-5019	882226-5519	882226-6019
20U	882226-2520	882226-3020	882226-3520	882226-4020	882226-4520	882226-5020	882226-5520	882226-6020
21U	882226-2521	882226-3021	882226-3521	882226-4021	882226-4521	882226-5021	882226-5521	882226-6021
22U	882226-2522	882226-3022	882226-3522	882226-4022	882226-4522	882226-5022	882226-5522	882226-6022
23U	882226-2523	882226-3023	882226-3523	882226-4023	882226-4523	882226-5023	882226-5523	882226-6023
24U	882226-2524	882226-3024	882226-3524	882226-4024	882226-4524	882226-5024	882226-5524	882226-6024

CLM Part No. Height	Width 650mm	Width 700mm	Width 750mm	Width 800mm	Width 850mm
4U	882226-6504	882226-7004	882226-7504	882226-8004	882226-8504
5U	882226-6505	882226-7005	882226-7505	882226-8005	882226-8505
6U	882226-6506	882226-7006	882226-7506	882226-8006	882226-8506
7U	882226-6507	882226-7007	882226-7507	882226-8007	882226-8507
8U	882226-6508	882226-7008	882226-7508	882226-8008	882226-8508
9U	882226-6509	882226-7009	882226-7509	882226-8009	882226-8509
10U	882226-6510	882226-7010	882226-7510	882226-8010	882226-8510
11U	882226-6511	882226-7011	882226-7511	882226-8011	882226-8511
12U	882226-6512	882226-7012	882226-7512	882226-8012	882226-8512
13U	882226-6513	882226-7013	882226-7513	882226-8013	882226-8513
14U	882226-6514	882226-7014	882226-7514	882226-8014	882226-8514
15U	882226-6515	882226-7015	882226-7515	882226-8015	882226-8515
16U	882226-6516	882226-7016	882226-7516	882226-8016	882226-8516
17U	882226-6517	882226-7017	882226-7517	882226-8017	882226-8517
18U	882226-6518	882226-7018	882226-7518	882226-8018	882226-8518
19U	882226-6519	882226-7019	882226-7519	882226-8019	882226-8519
20U	882226-6520	882226-7020	882226-7520	882226-8020	882226-8520
21U	882226-6521	882226-7021	882226-7521	882226-8021	882226-8521
22U	882226-6522	882226-7022	882226-7522	882226-8022	882226-8522
23U	882226-6523	882226-7023	882226-7523	882226-8023	882226-8523
24U	882226-6524	882226-7024	882226-7524	882226-8024	882226-8524

Color choose : Fill number 5, 1 in the

5 - RAL7035

1 - RAL9011

19" 232XX SERIES WALLMOUNT

Side Panel & Washer

For 232-AX

Side Panel (882411-xxxx)



Feature :

Save the space of installation and dismantled side panels with the pull-out type . It's fixed by the boss of rear panel and brackets of main frame .It with 4 cushions of rubber protect all of installation components.

Operations :

Whilst pressing the brackets of main frame , pull the side panel out quickly .

Dimension :

Depth : 300 mm , 350 mm , 400 mm , 450 mm , 500 mm , 550 mm , 600 mm ,
Height : 6U~24U

Material : Thickness sheet steel.

Finished : Powder coating in RAL7035or RAL 9011.

CLM Part No.	Width Lenght 300mm	Width 350mm	Width 400mm	Width 450mm	Width 500mm	Width 550mm	Width 600mm	For Model No.
6	882411-3006	882411-3506	882411-4006	882411-4506	882411-5006	882411-5506	882411-6006	CLM-232xx AC Type
7	882411-3007	882411-3507	882411-4007	882411-4507	882411-5007	882411-5507	882411-6007	CLM-232xx AC Type
8	882411-3008	882411-3508	882411-4008	882411-4508	882411-5008	882411-5508	882411-6008	CLM-232xx AC Type
9	882411-3009	882411-3509	882411-4009	882411-4509	882411-5009	882411-5509	882411-6009	CLM-232xx AC Type
10	882411-3010	882411-3510	882411-4010	882411-4510	882411-5010	882411-5510	882411-6010	CLM-232xx AC Type
11	882411-3011	882411-3511	882411-4011	882411-4511	882411-5011	882411-5511	882411-6011	CLM-232xx AC Type
12	882411-3012	882411-3512	882411-4012	882411-4512	882411-5012	882411-5512	882411-6012	CLM-232xx AC Type
13	882411-3013	882411-3513	882411-4013	882411-4513	882411-5013	882411-5513	882411-6013	CLM-232xx AC Type
14	882411-3014	882411-3514	882411-4014	882411-4514	882411-5014	882411-5514	882411-6014	CLM-232xx AC Type
15	882411-3015	882411-3515	882411-4015	882411-4515	882411-5015	882411-5515	882411-6015	CLM-232xx AC Type
16	882411-3016	882411-3516	882411-4016	882411-4516	882411-5016	882411-5516	882411-6016	CLM-232xx AC Type
17	882411-3017	882411-3517	882411-4017	882411-4517	882411-5017	882411-5517	882411-6017	CLM-232xx AC Type
18	882411-3018	882411-3518	882411-4018	882411-4518	882411-5018	882411-5518	882411-6018	CLM-232xx AC Type
19	882411-3019	882411-3519	882411-4019	882411-4519	882411-5019	882411-5519	882411-6019	CLM-232xx AC Type
20	882411-3020	882411-3520	882411-4020	882411-4520	882411-5020	882411-5520	882411-6020	CLM-232xx AC Type
21	882411-3021	882411-3521	882411-4021	882411-4521	882411-5021	882411-5521	882411-6021	CLM-232xx AC Type
22	882411-3022	882411-3522	882411-4022	882411-4522	882411-5022	882411-5522	882411-6022	CLM-232xx AC Type
23	882411-3023	882411-3523	882411-4023	882411-4523	882411-5023	882411-5523	882411-6023	CLM-232xx AC Type
24	882411-3024	882411-3524	882411-4024	882411-4524	882411-5024	882411-5524	882411-6024	CLM-232xx AC Type

Color choose : Fill number 5, 1 in the

5 - RAL7035

1 - RAL9011

19" 232XX SERIES WALLMOUNT

Washer of Mounting Angle (612590)



Feature :

It is used for preventing F-shaped mounting angle to moving.

Material : Thickness sheet steel.

Finished : Zinc-Plated.

CLM Part No.	For Model No.	Quantity
612590-00	612615-xx	2

Stand-off Angle (612752)



Feature :

It is used for preventing F-shaped mounting angle to moving.

Material : Thickness sheet steel.

Finished : Zinc-Plated.

CLM Part No.	For Model No.	Quantity
612752-00	612615-xx	2

Mounting Angle & Castor

For 232-AX

F-shaped Mounting Angle (612615-xx)

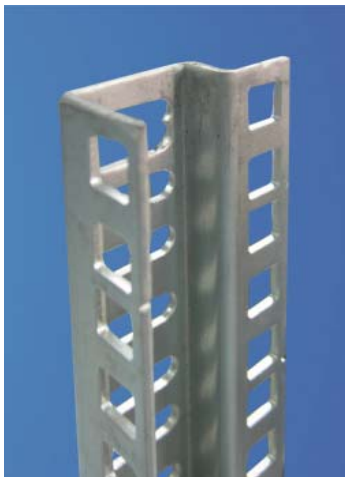

Feature :

The " F-shaped " mounting angles are SPCC section combined of main frame with screws has round holes integrated two strip rails section are punched 3 holes in 1U pitch pattern & M6 tapped screw thread for front & Rear side mounting Direct attached to 600mm cabinet's main frame for mounting 19" Rackmounted components.

Comes with 2 or 3 pair of depth strays on right & left side adjustable for irregular length 19" Rackmounted components.

Dimension : 4U~24U

Material : Thickness sheet steel.

Finished : Zinc-Plated.

Height (u)	Height (SU)	CLM Part No.	Quantity for		
			AA Type	AB Type	AC Type
4	7	612615-04	2	4	2
5	8	612615-05	2	4	2
6	10	612615-06	2	4	2
7	12	612615-07	2	4	2
8	14	612615-08	2	4	2
9	16	612615-09	2	4	2
10	17	612615-10	2	4	2
11	19	612615-11	2	4	2
12	21	612615-12	2	4	2
13	23	612615-13	2	4	2
14	24	612615-14	2	4	2
15	26	612615-15	2	4	2
16	28	612615-16	2	4	2
17	30	612615-17	2	4	2
18	32	612615-18	2	4	2
19	33	612615-19	2	4	2
20	35	612615-20	2	4	2
21	37	612615-21	2	4	2
22	39	612615-22	2	4	2
23	40	612615-23	2	4	2
24	42	612615-24	2	4	2

19" 232XX SERIES WALLMOUNT

Rigid Castor (662134)



For problem-free location changes.

Load capacity per castor:
25 kg static load

CLM Part No.	Bracker	Packing No.	Number	For Model No.
662134-00	No	882349-00	2	CLM-232xx AB Type (Rear Plinth)

Swing Castor (662131 / 662132)



For problem-free location changes.

Load capacity per castor:
25 kg static load

CLM Part No.	Bracker	Packing No.	Number	For Model No.
662132-00	No	882349-00	4	CLM-24xxx (Rear Plinth)(12u~24u)
662131-00	Yes	882350-00	2	CLM-232xx-xxAB (Front Plinth)



Bracket castor in Front
To use castor for removing stand server on floor

Summary for CLM-232xx-xx C Series



Features :

- Elegant design can be a wall decoration .
- Vented rectangle slot's top & bottom panel for high ventilation .
- The way of dismantling the side panel is pulling-in and pulling-out and fixed in front by screw.
- Unmovable roof & bottom panels .
- Suitable for corridor distribution & Wallmount distribution.
- Tempered glass fastened into a robust steel frame to become a security front door .
- The Package of Wallmount is not flat but is completely assembled.
- Powder coating for RoHS compliant .
- Black & Beige for color selections .

232xx-xxCA

Type CA



Dimensions :

Width 535 mm
 Depth 200mm , 250 mm , 300mm , 350mm , 400mm
 Height 4U , 6U , 9U , 12U , 15U , 18U , 21U

Applications:

- Network
 - Communication
 - Cable Management
- P.P. I63~I64

232xx-xxCB

Type CB



Dimensions :

Width 535 mm
 Depth 200mm , 250 mm , 300mm , 350mm , 400mm
 Height 4U , 6U , 9U , 12U , 15U , 18U , 21U

Applications:

- Network
 - Communication
 - Cable Management
- P.P. I65~I66

Package



Standard Functions



1
Passive Ventilator :
 The slots of roof , bottom panels are effecient for increasing heat-dissipation .



2
Usage of F-angle :
 Many rings can be set on the F-shaped mounting angles .



3
The fasten Side Panel :
 For the safety of side panel , side panels are fasten by screws.



4
The shape of Front Door :
 The vented design is effecient for ventilation and good-looking of wallmount .

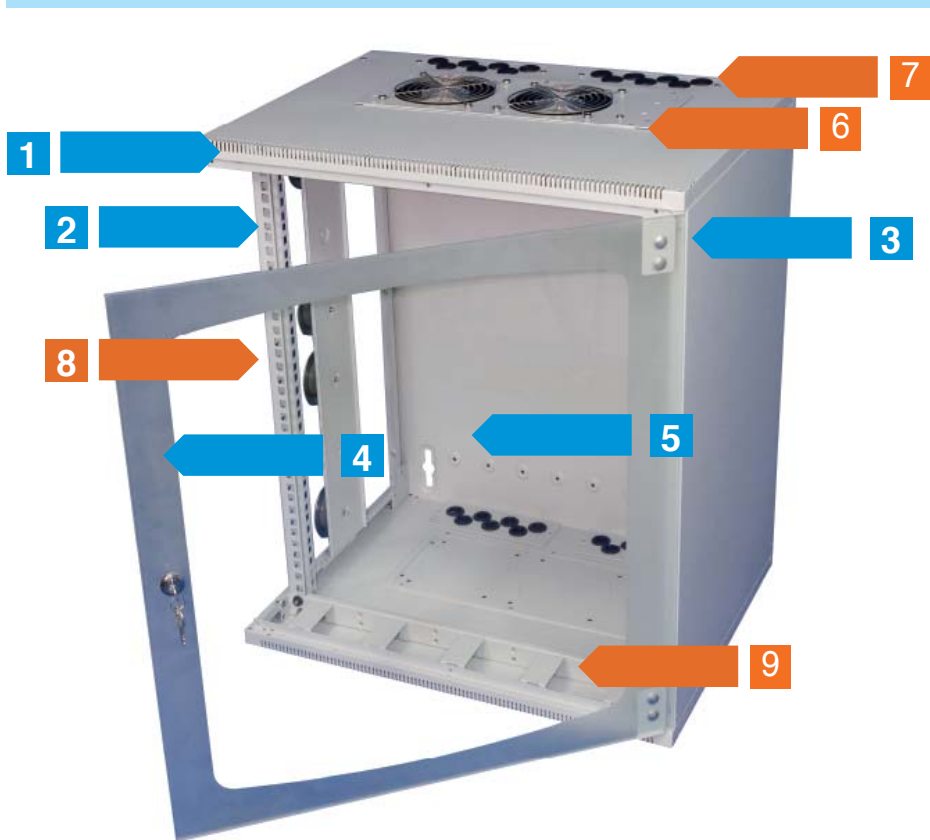

5
Wall Panel :
 The holes for rings are the cable management.

Optional Functions



6
Cooling Module :
 The module is easily assembled on the roof panel and bottom panel .



7
The Cable Entry :
 The entry can be flexible for managing the cable group. Optional for brush strip or rubber tube .



8
The Winding Tube :
 To integrate cables in the cabinet for safty and good-looking .



9
The Bracket for Cable :
 Used by Bracket to control the position of cable group.

Construction Overview CLM-232XX-XX C Series

19" 232XX SERIES WALLMOUNT

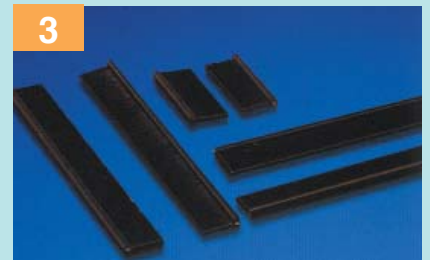

CLM-232xxx-xxXX Series Overview 19" Wallmount Rack for Distributors & Under Desk Mini Server

General Accessories(Optional)

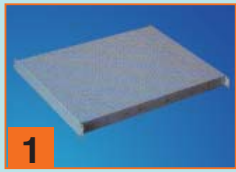

1



10



19



2



11



20

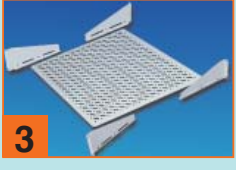

3



12



21

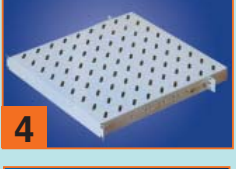

4



13



22



5



14



23



6



15



24



7



16



25



8



17



9



18

Standard Equipment: (Included)

1. CLM-882520-XX Tempered Glass Door(CA).....I67
2. CLM-882521-XX Vented Tempered Glass Door(CB).....I67
3. CLM-882519-XXXX Main Frame.....I68
4. CLM-612669-XXXX Side Panel.....I68
5. CLM-612671-XX F-shape Mounting Angle.....I69
6. CLM-612775-00 Vented Panel.....I69

Standard Equipment: (Optional)

1. CLM-882524-00 Cooling Module..... I70
CLM-612776-00 Cover
CLM-612777-00 Base
CLM-882138-XX 2AC-IN Fan (With I/O connector)
2. CLM-882544-00 Cooling Module (no base)..... I70
CLM-612776-00 Cover
CLM-882138-XX 2AC-IN Fan (With I/O connector)
3. CLM-882001-XX Brush Strips..... E59
4. CLM-882526-00 Cable-entry..... I70
CLM-612781-00 Vented Panel
CLM-312037-00 Rubber Cap
5. CLM-882522-00 Winding-cable Module..... I70
CLM-612782-00 Base
CLM-612785-00 Cover
6. CLM-612780-00 Bracket for Cable..... I69

Standard Equipment: (Optional)

1. CLM-882033 Overlapped Component shelf.....
2. CLM-882026 Adjustable Component shelf.....
3. CLM-882060 Vented & adjustable Component shelf
4. CLM-882104 Vented Fixed Component shelf.....
5. CLM-882025 Telescopic slide rails Slide-in Component shelf.....
6. CLM-882030 Drawer 1U,2U,3U.....
7. CLM-612027 Sheet steel blanking panels.....
CLM-612001 Aluminum blanking panels.....
8. CLM-312002-17/30 Earth straps.....
9. CLM-512007 Cable wiring duct.....
10. CLM-612199 Cable shunting rings,steel.....
11. CLM-882054 3 Sections server rail with Brackets
- CLM-882053 3 Sections server rail with Brackets
- CLM-882052 2 Sections server rail with Brackets.....
- CLM-882051 2 Sections server rail with Brackets.....
12. CLM-612030 Cable clamp rails.....
13. CLM-882089-00 cable shunting strips.....
14. SSL-1024 HUB 24 port Nway switch for Rack mounting..
SSL-1104/SSL-1108/SSL-1116KVN.....
15. CLM-882061 Power Socket strip & mounting bracket.....
16. CLM-612274 Patch panels.....
17. CLM-882066 Cable gland panel.....
18. CLM-911/2 Keyboard drawer with keyboard with mouse with
Telescopic slide rails.....
19. CLM-662097 Swelling Boon-Bolt hinger.....
20. CLM-882129 Component shelf.....
21. CLM-882142 Cabling management strip.....
22. CLM-882199 Cable shunting rings strip.....
23. CLM-662009 Shelf-tapping washers screw.....
24. CLM-882003 Cage Nuts.....
25. CLM-882170 1U Rack-mounted 3 fans
- CLM-882171 1U Rack-mounted 6 fans with 1 Pair of
Slide Rails.....
- CLM-882046 Active fan 3U.....

CLM-23220-xxCA □
W535 X D200 X H(4U to 21U)

CLM-23225-xxCA □
W535 X D250 X H(4U to 21U)

CLM-23230-xxCA □
W535 X D300 X H(4U to 21U)

CLM-23235-xxCA □
W535 X D350 X H(4U to 21U)

CLM-23240-xxCA □
W535 X D400 X H(4U to 21U)

Component Parts	Num	Model No.
Main Frame	1	882519
Temperated Glass Door	1	882520
Side Panel	2	612669
F-shaped mounting angle	2	612671
Cable-entry Panel	2	612775
Washers of F-shaped	4	612590
Self-tapping Screw 6#32	4	662039-06
Self-tapping Washer Screw	4	662009-08
Self-tapping Washer Screw	12	662009-12
Cage Nut M6	16	882003-06

Mechanical Drawing

Dimension Table:

Total Unit(U)	4	6	9	12	15	18	21
Total Height (mm)	238.0	326.9	460.25	583.60	726.95	860.3	993.65
Width	535	535	535	535	535	535	535
Clearance Size (1U=44.45mm)	177.8	266.7	400.05	533.4	666.75	800.1	933.45
Model No.	CLM- 23220-04CA □	23220-06CA □	23220-09CA □	23220-12CA □	23220-15CA □	23220-18CA □	23220-21CA □
Depth =200	200	200	200	200	200	200	200
Shipping Dimension							
CLM-662009-10	12	12	12	12	12	12	12
CLM-882003-06	12	12	12	12	12	12	12
G.W.							
Model No.	CLM- 23225-04CA □	23225-06CA □	23225-09CA □	23225-12CA □	23225-15CA □	23225-18CA □	23225-21CA □
Depth =250	250	250	250	250	250	250	250
Shipping Dimension							
CLM-662009-10	12	12	12	12	12	12	12
CLM-882003-06	12	12	12	12	12	12	12
G.W.							
Model No.	CLM- 23230-04CA □	23230-06CA □	23230-09CA □	23230-12CA □	23230-15CA □	23230-18CA □	23230-21CA □
Depth =300	300	300	300	300	300	300	300
Shipping Dimension							
CLM-662009-10	12	12	12	12	12	12	12
CLM-882003-06	12	12	12	12	12	12	12
G.W.							

Color choose : Fill number 5, 1 in the □
 5 - RAL7035
 1 - RAL9011

CLM-232XX-XXCA 19" WALL-MOUNT Rack

For Distributors & Under-Desk Mini Server Solutions

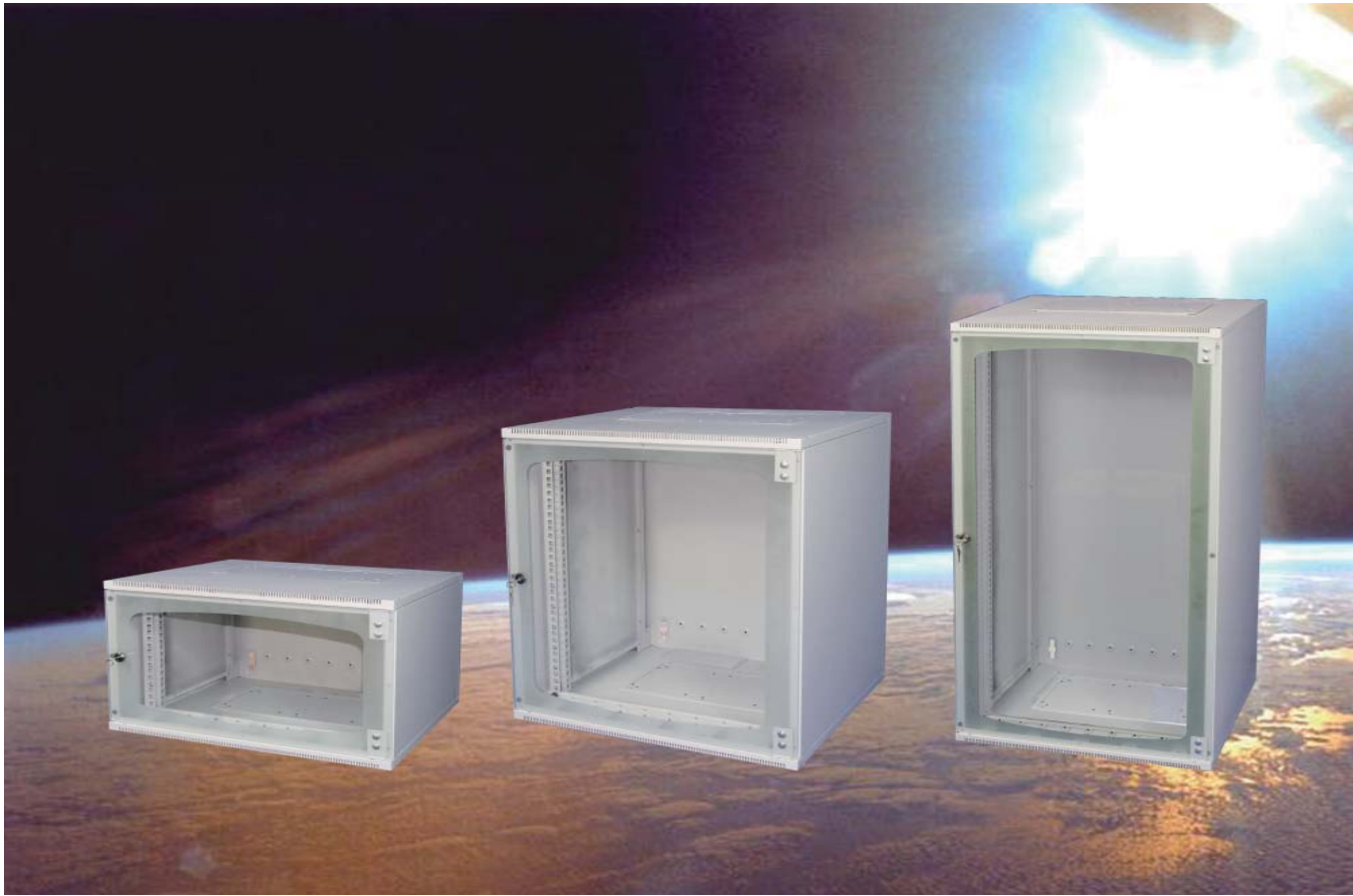

19" 232XX SERIES WALLMOUNT

Total Unit(U)	4	6	9	12	15	18	21
Total Height (mm)	238.0	326.9	460.25	583.60	726.95	860.3	993.65
Width	535	535	535	535	535	535	535
Clearance Size (1U=44.45mm)	177.8	266.7	400.05	533.4	666.75	800.1	933.45
Model No.	CLM- 23235-04CA □	23235-06CA □	23235-09CA □	23235-12CA □	23235-15CA □	23235-18CA □	23235-21CA □
Depth =350	350	350	350	350	350	350	350
Shipping Dimension							
CLM-662009-10	12	12	12	12	12	12	12
CLM-882003-06	12	12	12	12	12	12	12
G.W.							
Model No.	CLM- 23240-04CA □	23240-06CA □	23240-09CA □	23240-12CA □	23240-15CA □	23240-18CA □	23240-21CA □
Depth =400	400	400	400	400	400	400	400
Shipping Dimension							
CLM-662009-10	12	12	12	12	12	12	12
CLM-882003-06	12	12	12	12	12	12	12
G.W.							

CLM-23220-xxCB
W535 X D200 X H(4U to 21U)

CLM-23225-xxCB
W535 X D250 X H(4U to 21U)

CLM-23230-xxCB
W535 X D300 X H(4U to 21U)

CLM-23235-xxCB
W535 X D350 X H(4U to 21U)

CLM-23240-xxCB
W535 X D400 X H(4U to 21U)

Component Parts	Num	Model No.
Main Frame	1	882519
Vented Glass Door	1	882521
Side Panel	2	612669
F-shaped mounting angle	2	612671
Cable-entry Panel	2	612775
Washers of F-shaped	4	612590
Self-tapping Screw 6#32	4	662039-06
Self-tapping Washer Screw	4	662009-08
Self-tapping Washer Screw	12	662009-12
Cage Nut M6	16	882003-06

Mechanical Drawing

Dimension Table:

Total Unit(U)	4	6	9	12	15	18	21
Total Height (mm)	238.0	326.9	460.25	583.60	726.95	860.3	993.65
Width	535	535	535	535	535	535	535
Clearance Size (1U=44.45mm)	177.8	266.7	400.05	533.4	666.75	800.1	933.45
Model No.	CLM- 23220-04CB <input type="checkbox"/>	23220-06CB <input type="checkbox"/>	23220-09CB <input type="checkbox"/>	23220-12CB <input type="checkbox"/>	23220-15CB <input type="checkbox"/>	23220-18CB <input type="checkbox"/>	23220-21CB <input type="checkbox"/>
Depth =200	200	200	200	200	200	200	200
Shipping Dimension							
CLM-662009-10	12	12	12	12	12	12	12
CLM-882003-06	12	12	12	12	12	12	12
G.W.							
Model No.	CLM- 23225-04CB <input type="checkbox"/>	23225-06CB <input type="checkbox"/>	23225-09CB <input type="checkbox"/>	23225-12CB <input type="checkbox"/>	23225-15CB <input type="checkbox"/>	23225-18CB <input type="checkbox"/>	23225-21CB <input type="checkbox"/>
Depth =250	250	250	250	250	250	250	250
Shipping Dimension							
CLM-662009-10	12	12	12	12	12	12	12
CLM-882003-06	12	12	12	12	12	12	12
G.W.							
Model No.	CLM- 23230-04CB <input type="checkbox"/>	23230-06CB <input type="checkbox"/>	23230-09CB <input type="checkbox"/>	23230-12CB <input type="checkbox"/>	23230-15CB <input type="checkbox"/>	23230-18CB <input type="checkbox"/>	23230-21CB <input type="checkbox"/>
Depth =300	300	300	300	300	300	300	300
Shipping Dimension							
CLM-662009-10	12	12	12	12	12	12	12
CLM-882003-06	12	12	12	12	12	12	12
G.W.							

Color choose : Fill number 5, 1 in the

5 - RAL7035

1 - RAL9011

CLM-232XX-XXCB 19" WALL-MOUNT Rack

For Distributors & Under-Desk Mini Server Solutions

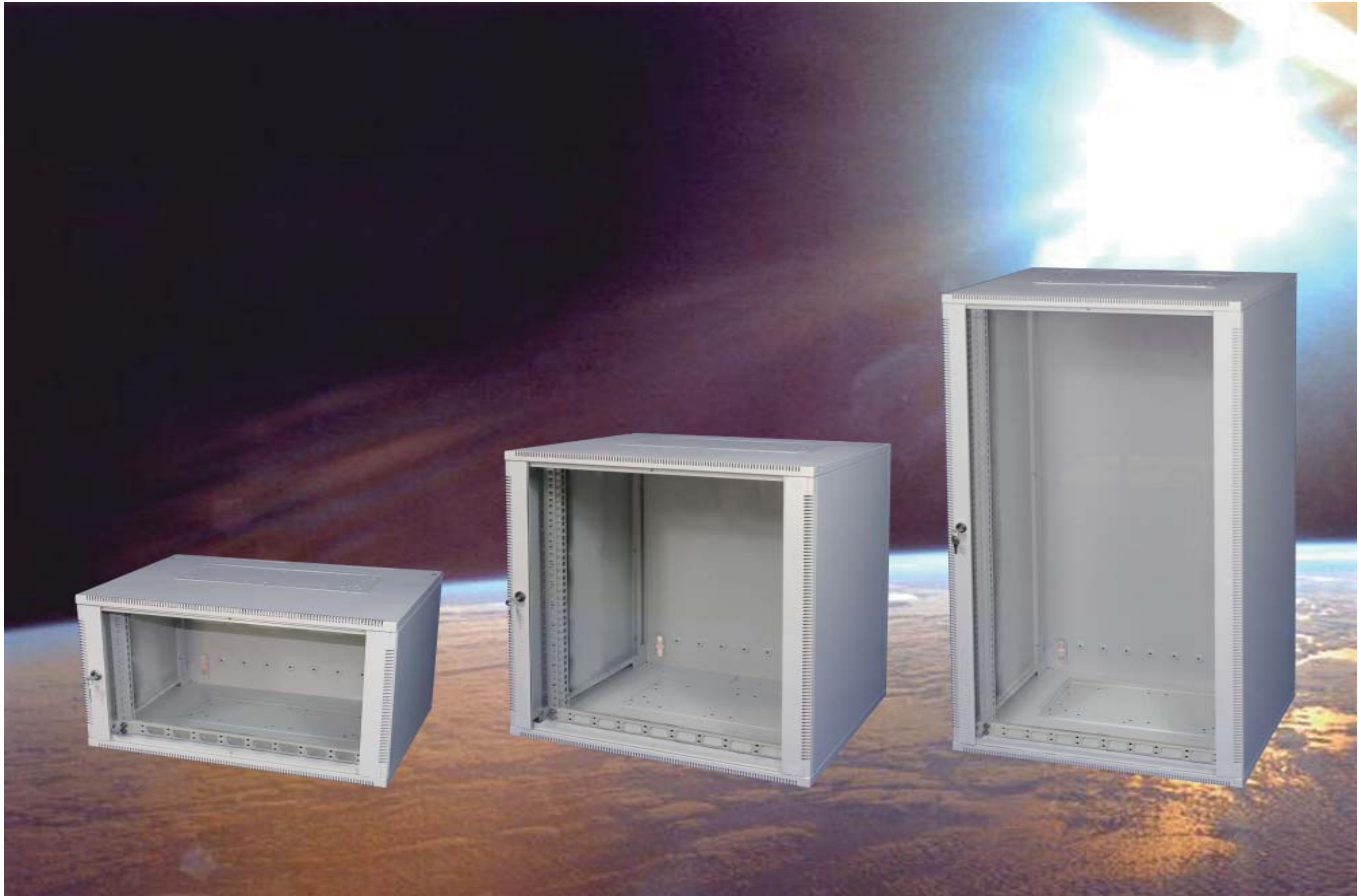

19" 232XX SERIES WALLMOUNT

Total Unit(U)	4	6	9	12	15	18	21
Total Height (mm)	238.0	326.9	460.25	583.60	726.95	860.3	993.65
Width	535	535	535	535	535	535	535
Clearance Size (1U=44.45mm)	177.8	266.7	400.05	533.4	666.75	800.1	933.45
Model No.	CLM- 23235-04CB □	23235-06CB □	23235-09CB □	23235-12CB □	23235-15CB □	23235-18CB □	23235-21CB □
Depth =350	350	350	350	350	350	350	350
Shipping Dimension							
CLM-662009-10	12	12	12	12	12	12	12
CLM-882003-06	12	12	12	12	12	12	12
G.W.							
Model No.	CLM- 23240-04CB □	23240-06CB □	23240-09CB □	23240-12CB □	23240-15CB □	23240-18CB □	23240-21CB □
Depth =400	400	400	400	400	400	400	400
Shipping Dimension							
CLM-662009-10	12	12	12	12	12	12	12
CLM-882003-06	12	12	12	12	12	12	12
G.W.							

Optional Accessories

For 232-CX

Cooling Module (882524)



Feature :

The Module is design for easily set on the wallout cabinet.
The fan kits can protect the damage from outside .

Dimension : 115 Vac and 230 Vac

Meterial : Thickness sheet steel.

Finished : Powder coating in RAL7035&RAL9011

CLM Part No.	For Model No.	Fan No.	Fan Num.
882524-00	CLM-232xx C series	CLM-882138	2



Cooling Module (882544)



Feature :

The Module is design for easily set on the wallout cabinet.
The fan kits can protect the damage from outside .

Dimension : 115 Vac and 230 Vac

Meterial : Thickness sheet steel.

Finished : Powder coating in RAL7035&RAL9011

CLM Part No.	For Model No.	Fan No.	Fan Num.
882544-00	CLM-232xx C series	CLM-882138	2



Cable Entry of roof & bottom panel (882526)



Feature :

The panel is used for a set of cable entry .

Meterial : Thickness sheet steel.

Finished : Powder coating in RAL7035&RAL9011



CLM Part No.	For Model No.	Panel No.	Cap No.	Pack No.
882526-00	CLM-232xx C series	CLM-612781	CLM-312037	4



19" 232XX SERIES WALLMOUNT

Optional Accessories

For 232-CX

Winding Module (882522)

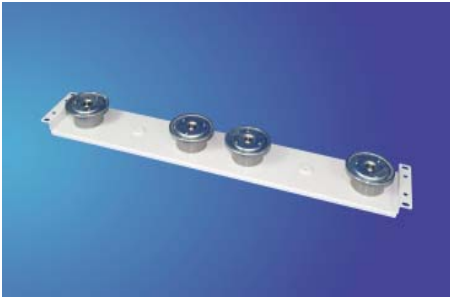

Feature :

The module is mounting on the side of main frame horizontally. The tube with diameter 48mm assembled on the panel can be the center of winding the cables or fibres for protecting the structure of cables or fibres. The maximum of the tube of one panel is 6 .

Material : Thickness sheet steel.

Finished : Powder coating in RAL7035&RAL9011



CLM Part No.	Height (U)	Standard Tubes Included	For Model No.	Pack No.
882522-04	4U	2	CLM-232xx C series	2
882522-06	6U	2	CLM-232xx C series	2
882522-09	9U	2	CLM-232xx C series	2
882522-12	12U	4	CLM-232xx C series	2
882522-15	15U	4	CLM-232xx C series	2
882522-18	18U	4	CLM-232xx C series	2
882522-21	21U	2	CLM-232xx C series	2

Cable Entry Panel (612780)



Feature :

This panel can be made the management of cable easier. And it's also made the strength of structure more stronger.

Material : Thickness sheet steel.

Finished : Powder coating in RAL7035&RAL9011

CLM Part No.	For Model No.	Collocated with	Pack No.
612780-00	CLM-232xx C series	CLM-612775	10



Brush Strip (882001)

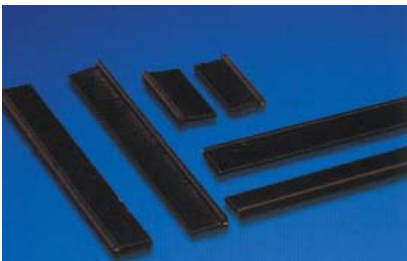

Feature :

The brush strips may be used for convenient cable entry and against dust coming into the cabinet . These may be fitted in numerous configurations . It's optional parts for roof panel & bottom panel

Material : Plastic

Supply Included : 1. CLM-512004 plastic strips
2. CLM-512005 Brush Strips

CLM Part No.	Brush Strip Width mm	Pack No.
882001-39	390	2

Solutions of Cable Management



Cable Management strips



The cable routing chamber has cutouts from above, into which the patch cables can be inserted. The cable management panel is equipped with a flap and quick-access to the cables from the rear.

Material: Sheet steel

Supply Includes: 1. cutout panel
2. Assembly parts.

Finished: powder coating in color
RAL 7035 or RAL 9011

CLM Part No.	U	Length mm	Pack No.
882142-1932	1	19"	1
882142-2132	1	21"	1
882142-2332	1	23"	1
882142-2432	1	24"	1

Cable Shunting Strip , 1U



A multi-punched pitch pattern holes brackets for setting a lot of cable shunting rings to do a good cabling management control against mixing situation For mounting on 1 or 2 pair of (19") mounting angles.

Material: Sheet Steel

Finished: powder coating in color
RAL 7035 or RAL 9011

CLM Part No.	Size Inch/mm	Pack No.	PCS/ CTN
612122-619	19"/600	1	10
612122-21	21"	1	10
612122-723	23"/700	1	10
612122-24	24"	1	10
612122-80	800 mm	1	10
612122-90	900 mm	1	10
612122-100	1000 mm	1	10

Bracket Strips

Technical 1: Ass'y cable Management Strip

Part No: 882199-xx



Technical 2: Ass'y power socket strip

Part No: 882061-xxx



Solutions of Cable Management

Cable ties for quick assembly



The super-fast solution for fixing cables to the Rack profile or mounting system parts, simply

CLM Part No.	Size Inch/mm	Pack No.
512014-10	100	100
512014-20	200	100
512014-25	250	100
512014-08	80	100

Cable wiring duct

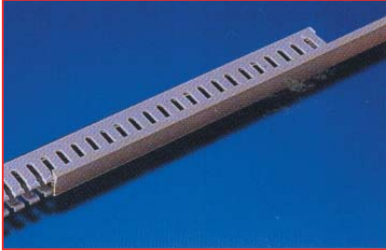

For side cable routing, the cable wiring duct is fastened to the side of the 482.6mm(19") mounting angles in an enclosure wide, the removable trimpanel. Which fastens onto the front and is secured with quick Release fasteners, provides convenient access to the cable distribution area.



Material:
PVC Plastic

CLM Part No.	for "U" Cabinet	Dimension	Height mm	Pack
5120076606	11	60 X 60 X 11U	444.5	1
5120076608	15	60 X 60 X 15U	622.3	1
5120076610	20	60 X 60 X 20U	844.5	1
5120076612	24	60 X 60 X 24U	1022.3	1
5120076406	11	60 X 45 X 11U	444.5	1
5120076408	15	60 X 45 X 15U	622.3	1
5120076410	20	60 X 45 X 20U	844.5	1
5120076412	24	60 X 45 X 24U	1022.3	1
512007251511	11	25 X 15 X 10U	444.5	1
512007251515	15	25 X 15 X 14U	622.3	1
512007251520	20	25 X 15 X 19U	844.5	1
512007251524	24	25 X 15 X 23U	1022.3	1

Cable Entry Management panel with Brush Strips 1U



A bracket punched cutout can click-into two brush strips as cable entry to mount on a pair of mounting angles for dust protection and make-up front outlooking as a perfect system equipment. A tooth-hooks line for interior cable clamp straps to against mixing cable for reaching management control.

Material: Sheet Steel

Finished: powder coating in color
RAL 7035 or RAL 9011

CLM Part No.	for mounting Angles	Pack No.	Set/ CTN
882066-19	1U X 19"	1	10
882066-21	1U X 21"	1	10
882066-23	1U X 23"	1	10
882066-24	1U X 24"	1	10

CLM Part No.	For Mounting Angles	Pack No.
882162-19	1U X 19"	1
882162-21	1U X 21"	1
882162-23	1U X 23"	1
882162-24	1U X 24"	1

Cable Shunting Rings



This cable shunting ring has a sort of kind size for a flexible cable shunting strips. may be routed on the mounting angles at any side of using cable tie in line with a system equipment. According to the cable size and volume to do a selection in shunting ring. There are some of items for routing different cable

CLM Part No.	Dimension	Pack No.
	H X W X D mm	
612199-26	60 X 24 X 11.3	20
612199-45	50 X 40 X 11.3	20
612199-46	60 X 40 X 11.3	20
612199-48	80 X 40 X 11.3	20
612199-68	80 X 60 X 11.3	20

other version available as request

Rails Sections



Fixer



882222-1U



2 Sections Server Rail for Even U

882052-xxx



3 Sections Telescopic Server Ball-Bearing Rail for Even "U" Components

882054-xxx

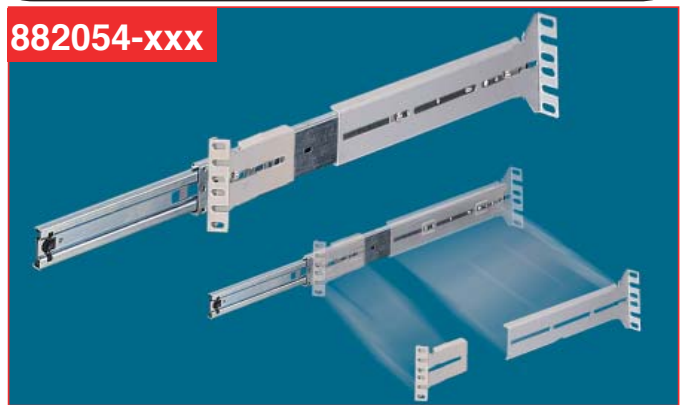

2 Sections Telescopic Server Ball-Bearing Rail for Odd "U" Components

882051-xxx



3 Sections Telescopic Server Ball-Bearing Rail for ODD "U" Components

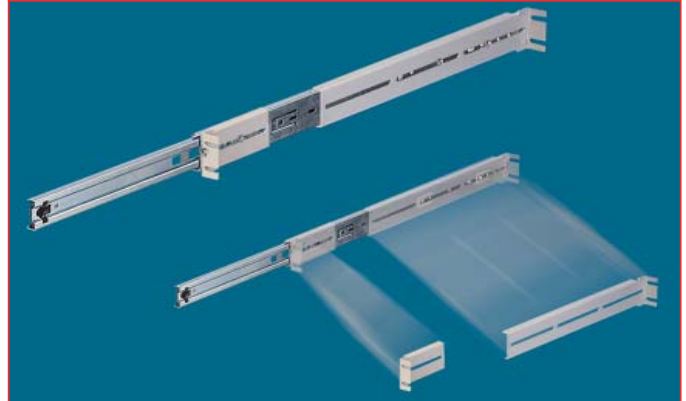

Odd Multi-Function Telescopic Ball-Bearing Server Rail

882223-xxx



Even Multi-Function Telescopic Ball-Bearing Server Rail

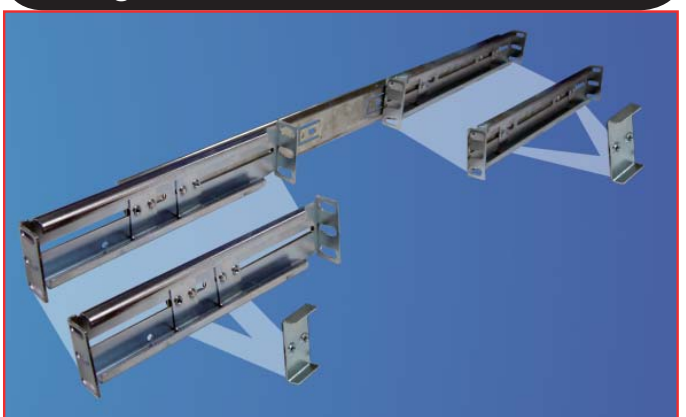

OPTIONAL ACCESSORIES

Drawers & Shelves

Data Drawer 1U, 2U, 3U for 600mm Depth Rack

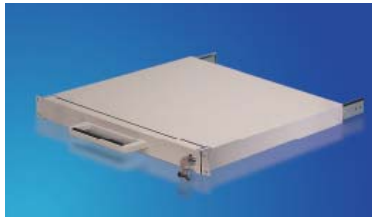

CLM Part No.	Height	Clearance Size	
		Width	Depth
882030-00	1U	448.2mm	400mm
882031-00	2U	448.2mm	400mm
882032-00	3U	448.2mm	400mm

Bracket part No. see page No. of K2

For front fixing on 482.6mm(19") mounting angles. With cover and telescopic slide rail to accommodate assignments Data, CD-ROM, FDD, Components & Assembly tools with key-Lock.

Material: Sheet Steel I.E. Series

Finish : Powder coating in Color RAL7035 RAL9011

Vented and adjustable Component shelf 2U, 4 Brackets, for installation mounting angles 482.6mm(19")

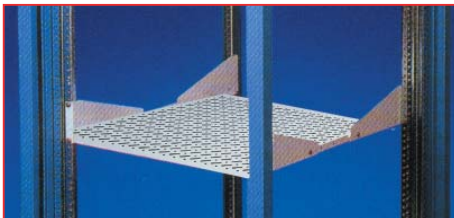

For mounting between 1 or 2 pairs of 482.6mm (19") mounting angles. 4-brackets design to reduce overlap component punched adjustable holes to match the different depth cabinet. Full Oval holes to increase heat-dissipation efficiency while putting components on the plate a spacer can be a stopper to stem a component dropping-down or totter.

Load capacity: 25 kgs surface load, static

Material: Thickness sheet steel

Supply Includes:

1. CLM-612182-xxx Vented plate
2. 2 CLM-612056-01 Left Brackets
2. 2 CLM-612057-01 Right Brackets
4. Assembly parts

Finished: Powder Coating in color RAL7035, RAL9011

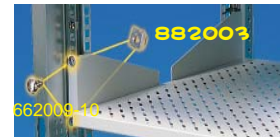

Adjustable Brackets for different Depth mounting Angles

882060-xxx

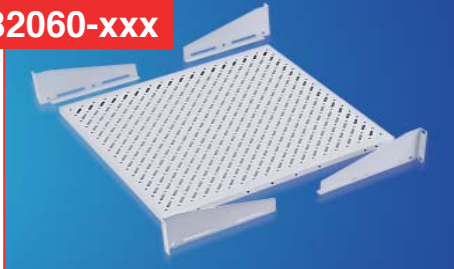

882342-xxx

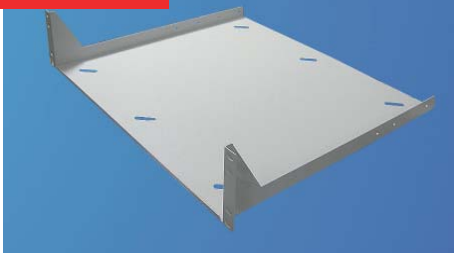

882026-xxx



CLM Part No.	CLM Part No.	Width mm	Plate depth	Pack No.
882060-619	882026-619	19"	430-630	1
882060-719	882026-719	19"	530-730	1
882060-819	882026-819	19"	630-830	1
882060-919	882026-919	19"	730-930	1
882060-621	882026-621	21"	430-630	1
882060-721	882026-721	21"	530-730	1
882060-821	882026-821	21"	630-830	1
882060-921	882026-921	21"	730-930	1
882060-623	882026-623	23"	430-630	1
882060-723	882026-723	23"	530-730	1
882060-823	882026-823	23"	630-830	1
882060-923	882026-923	23"	730-930	1
882060-624	882026-624	24"	430-630	1
882060-724	882026-724	24"	530-730	1
882060-824	882026-824	24"	630-830	1
882060-924	882026-924	24"	730-930	1

CLM Part No.	Width	Depth	Pack No.
882342-25	19"	250mm	1
882342-30	19"	300mm	1
882342-35	19"	350mm	1
882342-40	19"	400mm	1
882342-45	19"	450mm	1
882342-50	19"	500mm	1
882342-55	19"	550mm	1
882342-60	19"	600mm	1
882342-65	19"	650mm	1



Assembly Technical:

OPTIONAL ACCESSORIES

Drawers & Keyboard drawers

Slide-in Component shelf 1U, with 1 pair of Telescopic Sliders for Mounting angles 482.6mm(19")

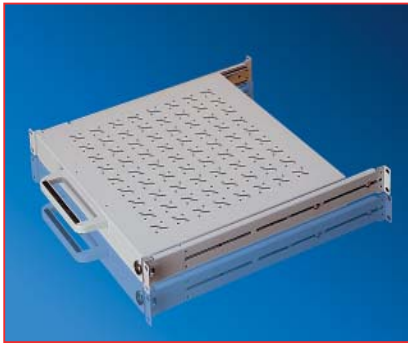

For mounting between 2 pairs of 482.6mm (19") mounting angles. Vented shelf integrated with a pair of Telescopic sliders design provides smooth touch & convenience usually put keyboard. Full oval holes plate to increase heat-dissipation efficiency while putting components on plate can use a spacer to be a stopper to stem for not dropping down or totter components.
Load capacity: 25kgs surface

CLM Part No.	For Cabinet Depth
882025-06	(W)600X600(D)
882025-08	(W)600X800(D)

Material: sheet steel

Supply Includes:

- 1 CLM-612083-xx Vented plate
- 1 pair of CLM-882126-xx 2 section Telescopic slide Rails
- 1 pair of CLM-612097-xxx Rail Brackets(in Rear)
- 1 CLM-612105-xxx Right Bracket
1 CLM-612106-xxx Left Bracket

Finished: Powder Coating in color RAL7035, RAL9011



OPTIONAL ACCESSORIES

1U, Keyboard Drawer for 2 pair of mounting angles 19"(482.6mm)

- CLM-9110 drawer only
- CLM-911 drawer & IPC keyboard.
- CLM-912 drawer & IPC keyboard set & libra trackball set.
- CLM-913 drawer & Touchpad IPC keyboard set
- CLM-912-1 drawer & track Ball built-in wireless keyboard set
- CLM-9101 drawer with mouse PAD plate only
- CLM-9101-1 with mouse PAD plate & IPC keyboard set
- CLM-9101-2 drawer with mouse PAD plate & IPC keyboard & Mouse set

Features:

For mounting between 2 pair of mounting angles. The drawer built Telescopic sliders on both sides to put IPC keyboard in whilst operating computer system free-holding to key-in data stability.

Material: sheet steel

Finished: Powder Coating in color RAL7035(Beige) or RAL9011(Black) as request

CLM Part No.	IPC keyboard	TRACK BALL	Touchpad	Mouse
CLM-9110	X	X	X	X
CLM-911	●	X	X	X
CLM-912	●	●	X	X
CLM-913	●	X	●	X
CLM-912-1	wireless keyboard	●	X	X
CLM-9101	X	X	X	X
CLM-9101-1	●	X	X	X
CLM-9101-2	●	X	X	●

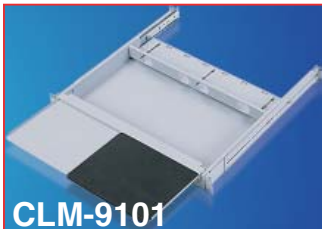

Cooling Solutions



Mounting in Bottom Frame/ Plinth



Front Mounting



Rear Mounting

1U Rack-mounted 3 fans for installation Mounting Angle 482.6 mm (19")

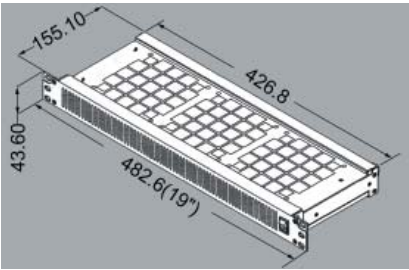

Material: Thickness Sheet Steel

Supply Includes: 1.1 CLM-612329-00 Top Guard Frame

2. 1 CLM-612333-00 Bottom Guard Frame
3. 2 CLM-612325-00 Mounting Brackets
4. 1 CLM-612337-00 Front panel
5. 1 CLM-612338-00 Rear panel
6. 3 CLM-272001-15/23 115V or 230V AC-IN high Rotation Ball-Bearing monitoring fans (see page of K41)
7. 1 CLM-312007-00 I/O switch with red Button(see page of K41)
8. 1 CLM-312016-75 Power socket with cable 750Lmm(see page of K41)
9. 1 CLM-312013-00 Connection cable(see page of K41)
10. Assembly parts

Fan specification see page No.E67

Finished: Powder coating in color RAL7035 or RAL9011

Patent Pending in Taiwan , China , USA , Germany

CLM Part No.	Width mm	Set of
882170-00	19"	1



882171-xxx



882172-xxx



882173-xxx

Active fan 3U for mounting angle 482.6mm



powerful axial fans can be installed in either a "blowing" or "extracting" arrangement. The rain canopy function of the ventgrille protects against both mechanical damage and penetrating dampness.

A Guide frame hood to achieve protection category is easy for making filter change. The design Active fan units boast a decisive advantage—the quick-fit assembly system for fan and filter units and outlet filters simply snap into place and voila.

Part No.CLM	Operating voltage	Air	Pack No.
882046-515	115V	Out	1
882046-523	230V	Out	1
882046-615	115V	IN	1
882046-623	230V	IN	1

Fan specification see page No.E67

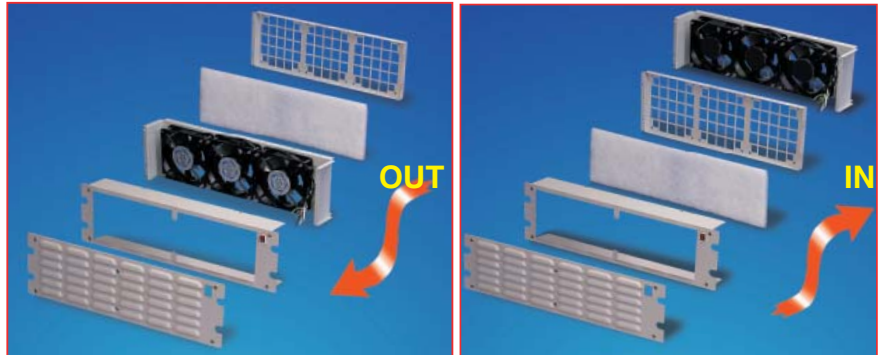

Air blow in-out direction

CLM-232xx-xxAA Mounting On Wall

Used Tool — "+"shaped Screw Driver
—CLM-68 key

Used Screws —CLM662097

DIY INSTALLATION

step 1



step1 Open Front Door :

Use keys to open the front door with turning left way.

step 2



step2 Remove Front Door :

Pull-down(up) spring-hinges inner the door to remove out.

step 3



step3 Open Side Doors :

Open the side panels with putting a pen into the positions which yellow arrow point .

step 4

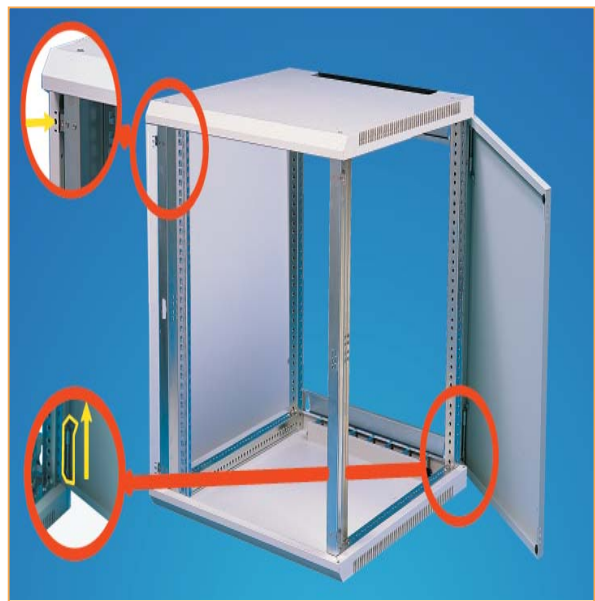

step4 Remove Side Panels :

To put a pin and press into the point-holes ,opening hinge inner the panels and remove it.

CLM-232xx-xxAA

Mounting On Wall

step 5



step5 Fix on the wall :

using Swelling Boom Bolt screw to bore through 4 fastened holes of the wall hinge on wall to achieve a swing function for removing installed or replacing equipment.

step 6



step6 Combine Side Doors :

combining the side panels with pulling up(down) spring-loaded pin on their left (right) side and putting the latches into the holes.

step 7



step7 Combine Front Door :

Combining the side panels with pulling up(down) spring-loaded pin on their left side

step 8



step8 Final

CLM-232xx-xxAA "D.I.Y" Menu



Step 1 Roof & Bottom Panels
Assembling the roof and bottom panels.



Step 2 Removing Mounting Angle
Check Mounting Angle where you want .



Step 3 Side panels

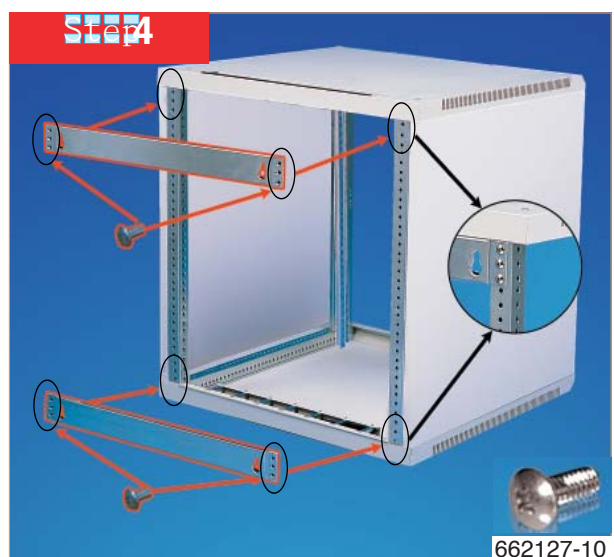

Step 4 Wall hinges



Step 5 Front door



Step 6 Final view

CLM-232xx-xxAB "D.I.Y" Menu

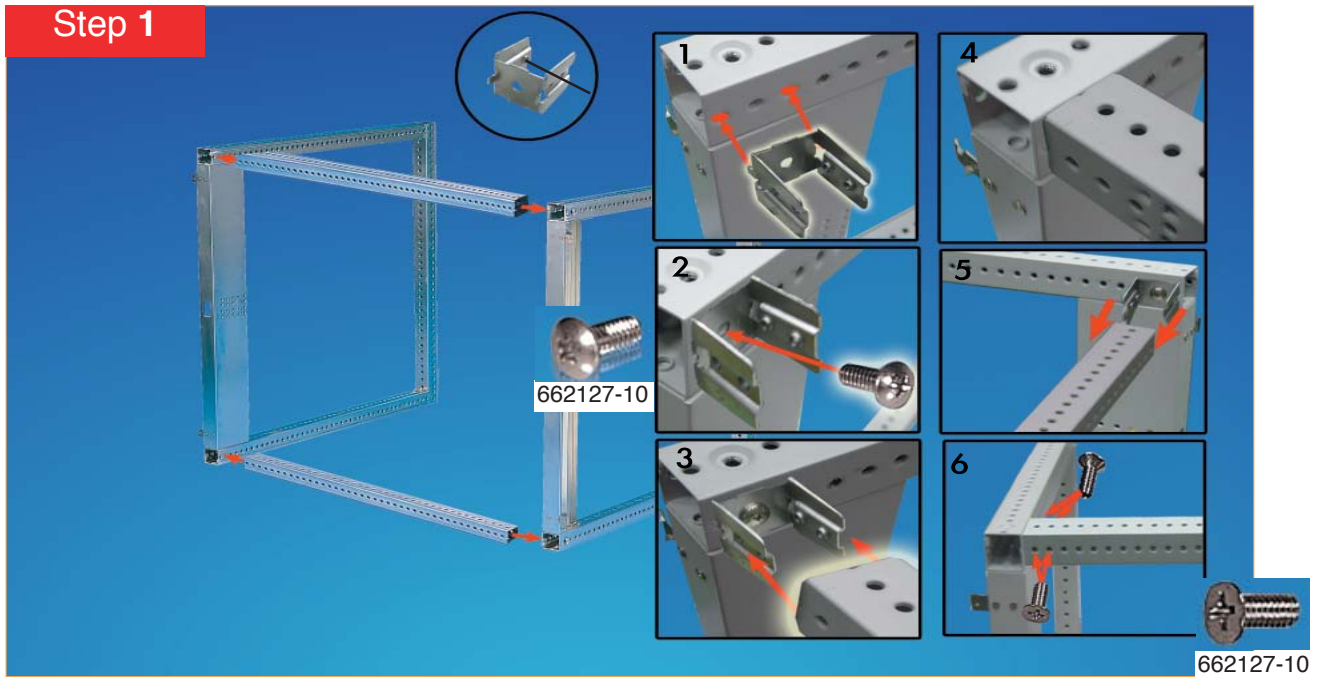

Step 1 Assembly Main Frames :

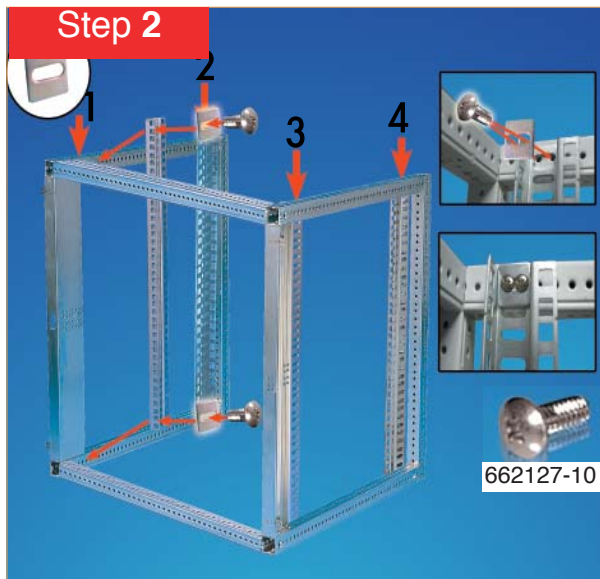

Step 2 Assembly F-shaped Mounting Angles :

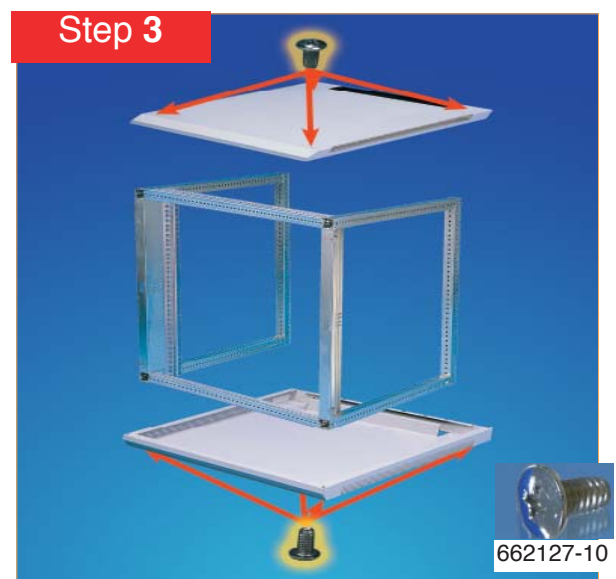

Step 3 Assembly Roof & Bottom Panels



Step 4 Assembly side panels



Step 5 Assembly Rear Door

DIY INSTALLATION

CLM-232xx-xxAB "D.I.Y" Menu



Step 6 Assembly Castor .



Step 7 Assembly Front door



Final

CLM-232xx-xxAC "D.I.Y" Menu

Step 1

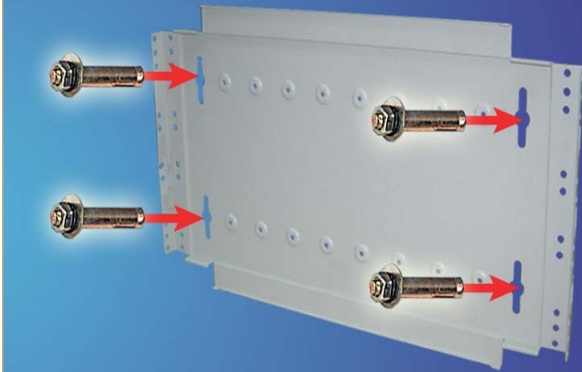

Step 1 Assembly wall panel

Step 2

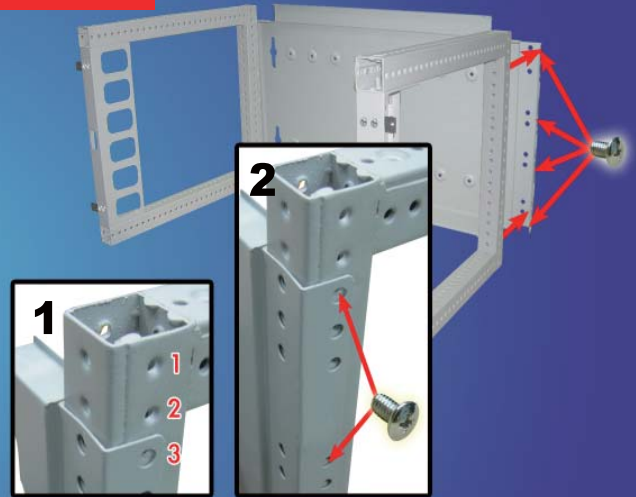

Step 2 Assembly main frame on the wall panel

Step 3

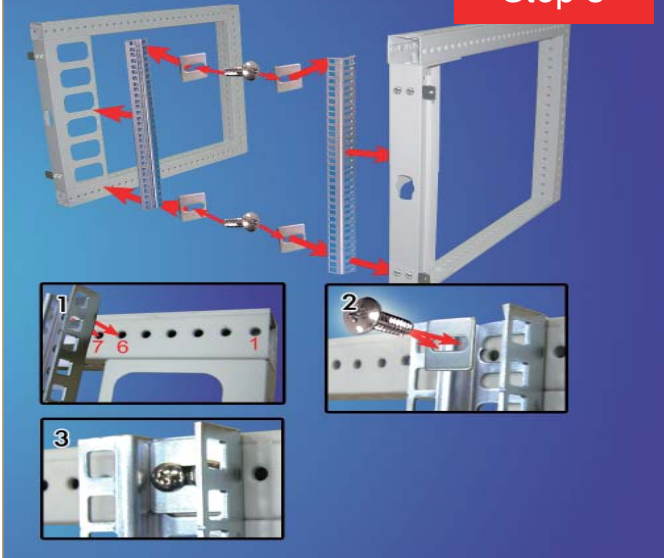

Step 3 Assembly f-shaped mounting angles

Step 4



Step 4 Assembly roof & bottom panels

Step 5

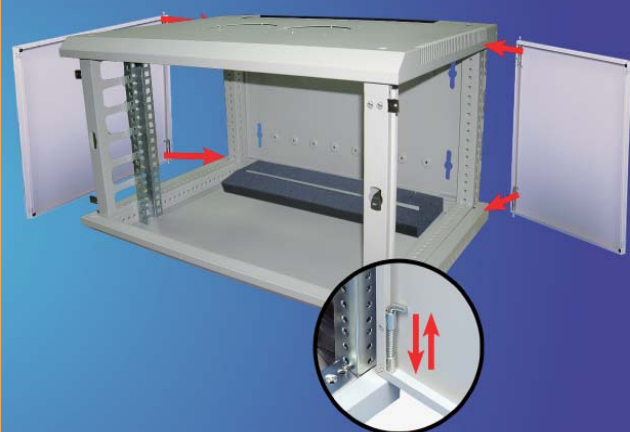

Step 5 Assembly side panels & front door

Step 6



Step 6 Finished View

DIY INSTALLATION